

Kingdom of Cambodia
Nation Religion King



Module 7
On
Technical Guide for Irrigation
Water Management

Prepared by: Ministry of water Resources and Meteorology

Dated: 22 / October / 2003

Kingdom of Cambodia
Nation Religion King



Appendix N°...១៧...of Prokash N° 15/...
Dated: 30 / 07 /2003

Module 7
On
Technical Guide for Irrigation
Water Management

Prepared by: Ministry of water Resources and Meteorology

Dated: 22 / October / 2003

TABLE OF CONTENTS

Section	Title	Page
1	Objective	1
2	Expected outcomes	1
3	Introduction	1
4	Crop Water Requirements	2
4.1	Definition	2
4.2	Factor Influencing Crop Water Requirements	3
4.3	Determination of Crop Water Requirement	3
4.3.1	Determination of ETo	3
4.3.2	Determination of Crop Factor	8
4.3.3	Calculation of Crop Water Requirement	9
5	Irrigation Water Requirements	11
5.1	Effective Rainfall	12
5.2	Irrigation Requirement of upland Crops or Non-rice crops	13
5.3	Irrigation Water Requirement of Rice	14
5.4	Irrigation Efficiency	17
5.5	Cropping Pattern and Crop Information	19
5.6	Scheme Irrigation Requirements	20
6	On-farm Water Management	23
6.1	Soils	23
6.2	Crop Factors	24
6.2.1	Which Growth Stages are Sensitive to Water Shortages	24
6.2.2	Cropping Pattern in Relation to Water Availability	26
6.3	Climate Factors	26
6.4	Irrigation Schedule for Crops other than Rice	27
6.5	irrigation Schedule for Paddy Rice	28
6.5.1	1. Irrigation for the rice nursery	28
6.5.2	2. Preparation of the rice fields	28
6.5.3	3. Transplanting of the seedlings	29
6.5.1	6.5.1 Rice Growth Stages	29
6.5.2	6.5.2 Irrigation Water need of Rice	30
6.6	Conjunctive Use of Water	30
6.6.1	6.6.1 Benefit from Conjunctive Use of Water	30
7	Irrigation System	32
7.1	Intake Structure or Pumping Station	32
7.2	Conveyance and Distribution System	33
7.2.1	7.2.1 Open Canal	33

7.2.2	Canal Structure	35
7.3	Field Application Systems	38
7.4	Drainage Systems	40
7.4.1	Drainage needs	40
7.4.2	Symptoms	40
7.4.3	Drainage as Return Flow as Water Supply	41

**TRAINING MANUAL FOR
PARTICIPATORY IRRIGATION MANAGEMENT AND DEVELOPMENT
IN CAMBODIA**

Module 7

**TECHNICAL GUIDE FOR
IRRIGATION WATER MANAGEMENT**

1. Objective

1. To provide basic knowledge and skills to FWUC leaders, through members of the FWUC Support Team, and possibly other local government staff, to enable the Support Team to build strong capacity within the FWUC to manage their irrigation system in a productive and sustainable manner, consistent with the aspirations and irrigation service objectives of the farmers themselves.
2. To promote appreciation among FWUC leaders about the importance of, and methods for, identifying clear irrigation service objectives through a process of democratic consensus building among FWUC members.
3. To provide the necessary knowledge and skills to FWUC leaders to manage their irrigation system in a productive and sustainable manner, consistent with the farmer consensus about irrigation service objectives.
4. To provide the necessary knowledge and skills to FWUC leaders to enable them to develop an on-farm water management plan and relevant rules.

2. Expected Outcomes

1. FWUC Support Team members will function effectively to build capacity of FWUC to manage their irrigation systems effectively.
2. FWUC leaders will be able to build consensus among farmers about irrigation service objectives.
3. FWUC leaders will be able to develop and implement an irrigation service plan which is acceptable to FWUC members.
4. The FWUC will prepare and adopt a locally appropriate FWUC constitution, by-laws and transfer agreement (in collaboration with the FWUC Support Team).
5. Summary of module discussion and results of exercises.

3. Introduction

All field crops need soil, water, air and light (sunshine) to grow. The soil gives stability to the plants; it also stores the water and nutrients which the plants can take up through their roots. The sunlight provides the energy which is necessary for plant growth. The air allows the plants to “breath”.

Without water crops cannot grow. Too much water is not good for many crops either. Apart from paddy rice, there are very few crops which like to grow “with their feet in the water”. The most well-known source of water for plant growth is rain water. There are two important questions which come to mind:

What to do if there is too **much** rain water?

What to do if there is too **little** rain water?

If there is too much rain, the soil will be full of water and there will not be enough air. Excess water must be removed. The removal of excess water either from ground surface or from the root zone - is called **drainage**.

If there is too little rain, water must be supplied from other sources, which is called **irrigation**. The two major factors which determine the amount of irrigation water which is needed are:

- i) The total water need of the various crops
- ii) The amount of rain water which is available to the crops.

In this module we will discuss how to make estimation of the crop and irrigation water requirements using simple methods.

4. Crop Water Requirements

4.1 Definition

Crops need water for **transpiration** and **evaporation**.

The plant roots suck or extract water from soil to live and grow. The main part of this water does not remain in the plant, but escapes to the atmosphere as vapor through the plant's leaves and stem. This process is called **transpiration**. Transpiration happens mainly during day time.

Water from an open water surface escapes as vapor to the atmosphere during the day. The same happens to water on the soil surface and to water on the leaves and stem on a plant. This process is called **evaporation** (Fig. 1).

The water requirement of the crop thus consists of transpiration plus evaporation. Therefore, the crop water requirement is also called "**evapotranspiration**".

The water requirements of a crop are usually expressed in mm/day, mm/month or mm/season.

Suppose the water requirement of a certain crop is 6 mm/day. This means that each day the crop needs a water layer of 6 mm over the whole area on which the crop is grown (Fig. 2). It does not mean that this 6 mm has to indeed be supplied by rain or irrigation every day.

It is, of course, still possible to supply, for example, 42 mm of irrigation every 7 days. The irrigation water will then be stored in the root zone and gradually be used by the plants: every day 6 mm.

The crop water requirements (ET crop) is defined as the depth (or amount) of water needed to meet the water loss through evapotranspiration. In other words, it is the amount of water needed by the various crops to grow optimally.

The crop water requirements always refer to a crop grown under optimal conditions. This means a uniform crop, actively growing, completely shading the ground, free of diseases, and favorable soil conditions (including fertility and water). The crop thus reaches its full production potential under the given environment.

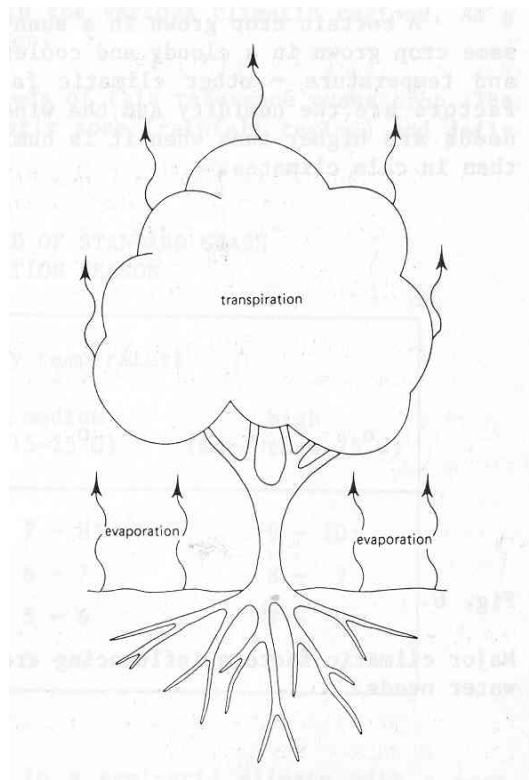

Fig.1 Evapotranspiration

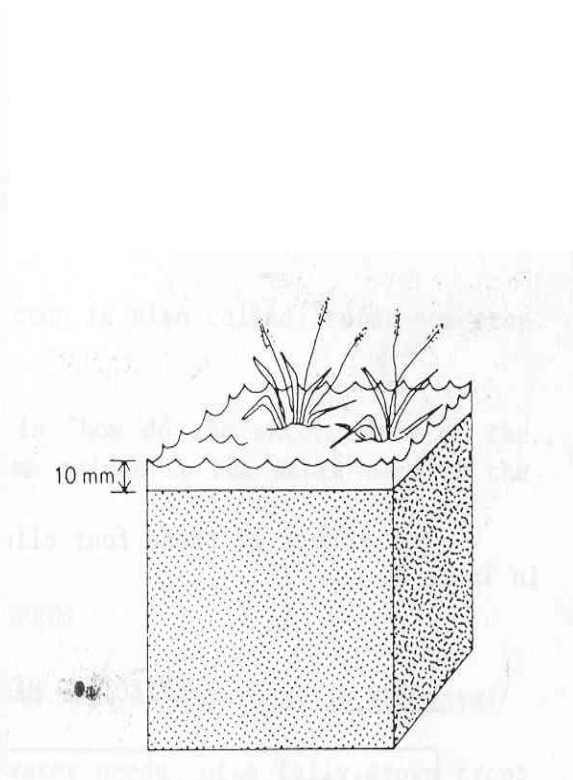

Fig. 2 A crop water need of 10 mm/day

4.2 Factors Influencing Crop Water Requirements

The crop water requirements mainly depend on:

- the **climate**: for example, in a sunny and hot climate crops need more water per day than in a cloudy and cool climate.
- the **crop type**: crops like rice and sugarcane need more water than crops like beans and wheat.
- the **growth stage**: fully grown crops need more water than crops that have just been planted.

Major **Climatic factors** influencing crop water requirements are:

- Sunshine
- Temperature
- Humidity
- Windspeed

The influence of the climate on crop water requirements is given by the reference crop evapotranspiration (ET_o). The ET_o is usually expressed in millimeters per unit of time, e.g. mm/day, mm/month, or mm/season. Grass has been taken as the reference crop.

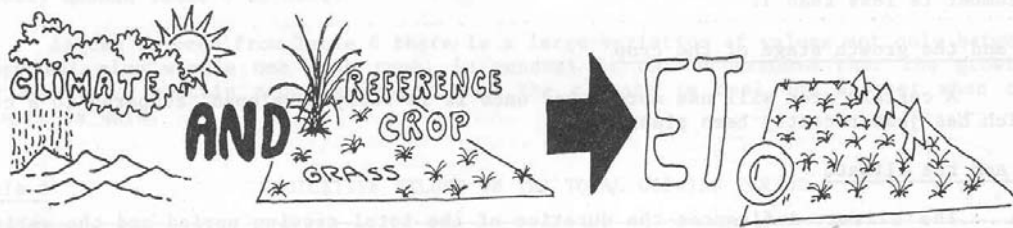

Definition of ET_o: ET_o is the rate of evapotranspiration from a large area, covered by green grass, 8 to 15 cm tall, which grows actively, completely shades the ground and which is not short of water.

The influence of the **crop type** on the water requirements is important in two ways:

- The crop type has an influence on the daily water requirements of a fully grown crop, meaning a fully developed rice crop will need more water than a fully developed maize crop.
- The crop type determines the duration of the total growing season of the crop. For example, the daily water need of sugarcane may be less than the daily water need of rice but the **seasonal water** requirements of sugarcane will be higher than that of rice because the duration of the total growing season of sugarcane is longer than that of rice.

A fully grown crop will need more water than a crop which has just been planted. As discussed before, the crop water requirements or crop evapotranspiration consists of transpiration by the plant and evaporation from the soil and plant surface. When the plants are very small the evaporation will be more important than transpiration. When the plants are fully grown the transpiration is more important than the evaporation. Figure 3 shows in a schematic way the various development or growth stages of a crop.

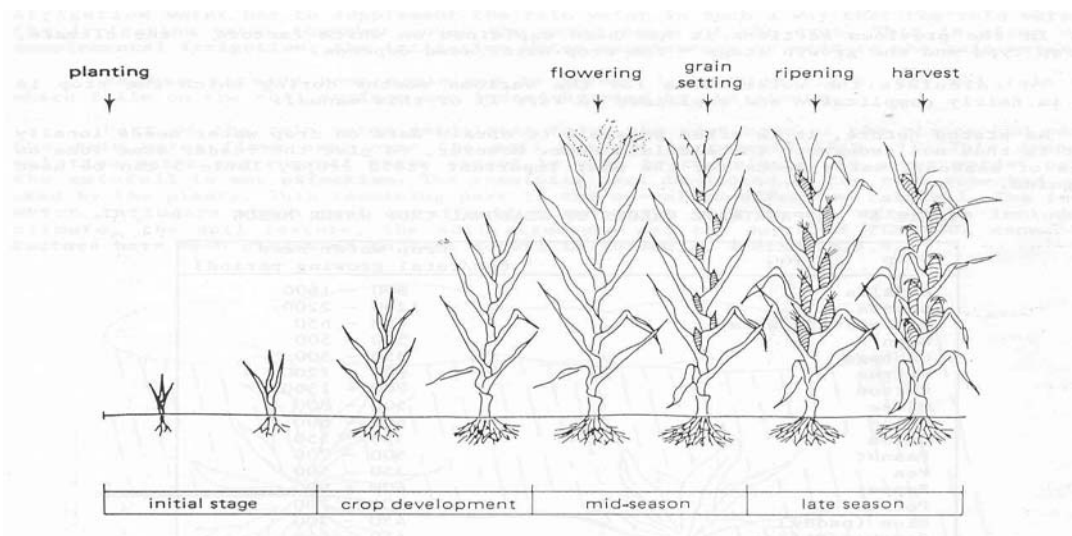

Fig. 3 Growth stages of a crop

The influence of the crop type and growth stage on the crop water requirements is expressed as crop factor or crop coefficient (K_c). The relationship between the reference grass crop and the crop actually grown is given by this crop factor, as shown in the following formula:

$$E_{To} \times K_c = ET_{\text{crop}}$$

Where,

ET_{crop} = crop evapotranspiration or crop water need (mm/day)
 K_c = crop factor
 E_{To} = reference evapotranspiration (mm/day)

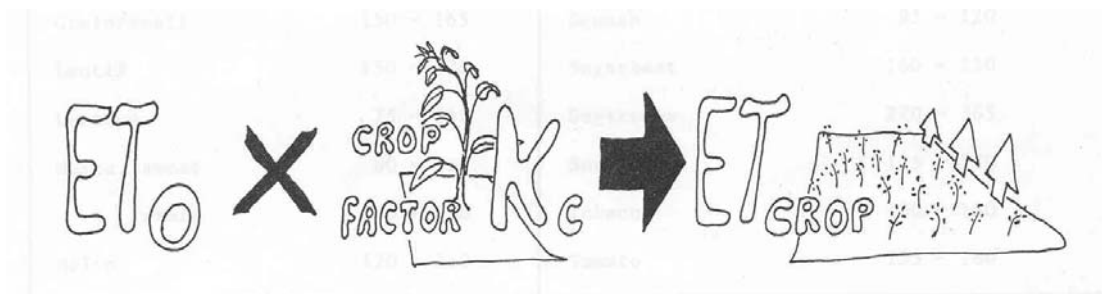

4.3 Determination of Crop Water Requirements

To determine the crop water requirement of a certain crop, therefore, we need to estimate **reference crop evapotranspiration (E_{To})** and to know the **crop factor (K_c)**.

4.3.1 Determination of E_{To}

There are several empirical methods to determine the E_{To} using climatic data. The Food and Agricultural Organization of the United Nations (FAO) recommends using the Penman-Monteith Method to estimate E_{To} from the climatic data. But the method requires detailed data on climate and local conditions, which are often not available in many areas. Moreover, the procedure to estimate manually is very lengthy, time consuming and prone to error. So computation of E_{To} by this method is often computerized. Many software packages are available to estimate E_{To} using this method and various other methods. The software “CROPWAT”, developed by FAO is widely used and is available free of charge. A brief description about CROPWAT is given in the appendix.

Here we will show you how to estimate E_{To} by simple methods, which are also recommended by FAO in case there are not all or accurate data available to estimate by Penman-Monteith Method. These are:

- a) Hargreaves Method
- b) Pan Evaporation Method

a) Hargreaves Method

This method estimates ETo using maximum and minimum temperature. The equation is:

$$ETo = 0.0023(T_{\text{mean}} + 17.8) (T_{\text{max}} - T_{\text{min}})^{0.5} R_a$$

Where,

ETo	=	Reference crop evapotranspiration (mm/day)
T _{mean}	=	Mean air temperature (°C)
T _{max}	=	Maximum air temperature (°C)
T _{min}	=	Minimum air temperature (°C)
R _a	=	Extraterrestrial radiation (mm/day)

R_a is the amount of radiation received at the top of the atmosphere and is dependent on latitude and the time of the year only. Therefore, R_a has a standard value for a certain location for a certain time. The standard table for R_a values is given in Table A.1 of the Appendix.

Therefore, if we have only the maximum and minimum temperature of a certain place then we can estimate ETo using this method.

Example 1: Estimate the ETo for the month of April

Given

Latitude = 36°N

Mean T_{max} in April = 29.5°C

Mean T_{min} in April = 19.5°C

Calculation

$$ETo = 0.0023(T_{\text{mean}} + 17.8) (T_{\text{max}} - T_{\text{min}})^{0.5} R_a$$

$$T_{\text{mean}} = (T_{\text{max}} + T_{\text{min}}) / 2 = (29.5 + 19.4) / 2 = 24.5^\circ\text{C}$$

R_a for the month of April with latitude 36°N (from table A.1 in Appendix) = 14.7 mm/day

$$ETo = 0.0023(24.5 + 17.8) (29.5 - 19.5)^{0.5} \times 14.7 = 4.52 \text{ mm/day}$$

b) Pan Evaporation Method

The evaporation rate from pans filled with water is easily obtained. In the absence of rain, the amount of evaporation during a period (mm/day) corresponds to the decrease in water depth in that period. The pan provides a measure of the integrated effect of radiation, wind, temperature and humidity on the evaporation from an open water surface. Although the pan responds in a similar fashion to the same climatic factors affecting crop transpiration, several factors produce significant differences in loss of water from a water surface and from a cropped surface.

Therefore, pan evaporation is related to the reference evapotranspiration by an empirically derived **pan coefficient**. The equation is:

$$E_{To} = K_p \times E_{pan}$$

Where,

- E_{To} = Reference crop evapotranspiration (mm/day)
- K_p = Pan coefficient
- E_{pan} = Pan evaporation (mm/day)

Many different types of evaporation pans are used. The best known and widely used pan is the Class A pan (Fig. 4) developed by the United States Department of Agriculture (USDA).

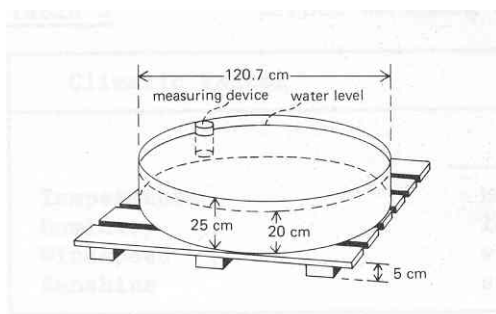

Fig. 4 Class A pan

In selecting the appropriate pan coefficient, not only the pan type, but also the ground cover in the station, its surroundings as well as the general wind and humidity conditions, should be checked. The sitting of the pan and the pan environment also influence the results. This is particularly so where the pan is placed in fallow rather than cropped fields. Two cases are commonly considered:

Case A where the pan is sited on a short green (grass) cover and surrounded by fallow soil; and

Case B where the pan is sited on fallow soil and surrounded by a green crop (Fig. 5).

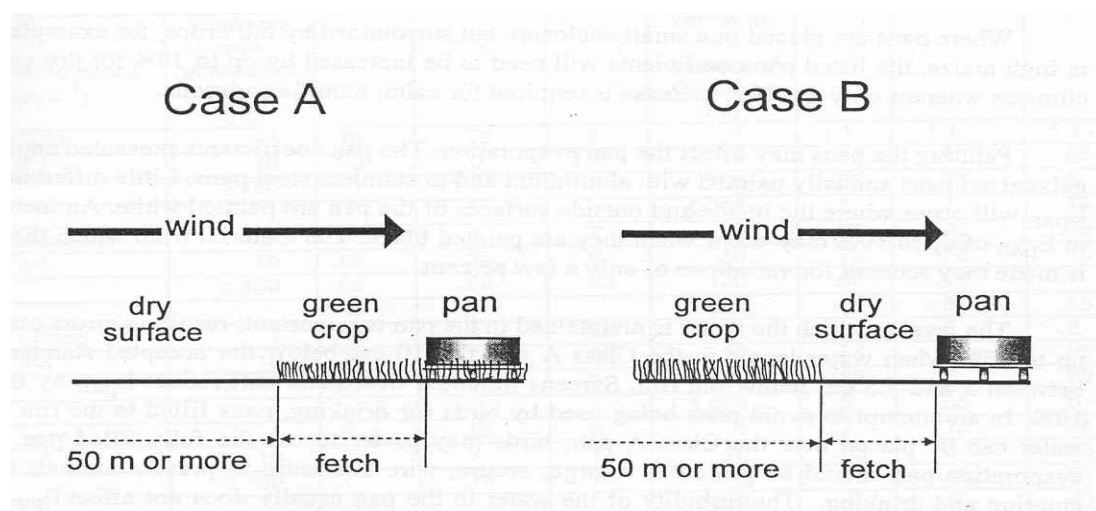

Fig. 5 Two cases of evaporation pan sitting and their environment

Pan coefficients for the Class A pan for different ground cover and climatic conditions are given in the appendix (Table A.2).

Example 2: Determination of ETo by Pan Evaporation method

Given:

July, Epan = 8.0 mm/day from Class A Pan; RHmean = medium, wind moderate; pan station is located within a cropped area of several hectares.

Calculation:

Since pan station is covered by grass and is surrounded by some 100 m of cropped area, Case A applies.

From table A.2 in the appendix, for moderate wind and medium humidity value of Kp = 0.75,

$$ETo = Kp \times Epan = 0.75 \times 8.0 = 6.0 \text{ mm/day.}$$

4.3.2 Determination of Crop Factor

The crop factor or crop coefficient Kc mainly depends on:

- the type of crop,
- the growth stages of the crop,
- the climate.

Thus to determine the crop factor, Kc, it is necessary to know for each crop, the total length of the growing season and the lengths of the various growth stages. The determination of the Kc values for the various growth stages of the crops involves several steps:

- **Step 1** – Determination of the total growing period of each crop,
- **Step 2** – Determination of various growth stages of each crop,
- **Step 3** – Determination of the Kc values for each crop for each growth stage.

Step -1: The total growing period (in days) is the total period from sowing or transplanting to the last day of the harvest. Since the growing period heavily depends on local circumstances (e.g. local crop varieties) it is always best to obtain these data locally. Usually, farmers and agriculture extension workers know about the growing period of local crops.

Step – 2: Once the total growing period is known, the duration (in days) of the various growth stages has to be determined.

The total growing period is divided into 4 growth stages (see Fig. 3).

- i) The initial stage: this is the period from sowing or transplanting until the crop covers about 10% of the ground.

- ii) The crop development stage: this period starts at the end of the initial stage and lasts until the full ground cover has been reached (ground cover 70-80%); it does not necessarily mean that the crop is at its maximum height.
- iii) The mid-season stage: this period starts at the end of the crop development stage and lasts until maturity; it includes flowering and grain-setting.
- iv) The late season stage: this period starts at the end of the mid-season stage and lasts until the last day of the harvest; it includes ripening.

Table 1 shows the duration of the various growth stages for some of the major field crops.

Step – 3: Per crop, four crop factors have to be determined: one crop factor for each of the four growth stages. Table 2 indicates per crop the Kc values for each of the four growth stages. In some cases local values of crop factors for the major crops are available on the weekly or monthly basis. It is always recommended to use the local values if available. Only if no data are available locally should Table 2 be used.

Table 1 Length of crop development stages of selected field crops

Crop	Initial stage	Development stage	Mid-Season	Late-Season	Total Period	Plant date	Region
Maize(sweet)	20	20	30	10	80	March	SEA
Maize (grain)	20	35	40	30	125	April	Dry, cool
Rice	20	30	40	30	120		
Soybeans	15	15	40	15	85	Dec	SEA
Tomatoes	25	40	50	25	150		

Table 2 Crop coefficient of different crops

Crop	Crop development stages				Total growing period
	Initial stage	Development stage	Mid-season	Late-season	
Maize(sweet)	0.3-0.5	0.7-0.9	1.05-1.20	1.0-1.15	0.8-0.95
Maize (grain)	0.3-0.5	0.7-0.85	1.05-1.20	0.8-0.95	0.75-0.90
Rice	1.1 [*] -1.15 [§]	1.1-1.15	1.1-1.3	.95-1.05	1.05-1.2
Soybeans	0.3-0.4	0.7-0.8	1.0-1.15	0.7-0.8	0.75-0.9
Tomato	0.4-0.5	0.7-0.8	1.05-1.25	0.8-0.95	0.75-0.9

Note: ^{*} (first figure) - under high humidity (RHmin > 70%) and low wind (u < 5 m/sec)

[§] (second figure) – Under low humidity (RHmin < 20%) and strong wind (u > 5 m/sec)

4.3.3 Calculation of Crop Water Requirements

Once the reference crop evapotranspiration and crop factor are determined, the crop water requirements are estimated using the formula:

$$ET_{\text{crop}} = ET_0 \times K_c$$

Although the formula to calculate ET crop is easy to apply, there are still some practical problems to be overcome, which can best be explained using an example.

Example 3: Determination of the crop water requirement of tomatoes.

Given

Month	Jan	Feb	Mar	Apr	May	Jun	Jul
Eto (mm/day)	4.0	5.0	5.8	6.3	6.8	7.1	6.5
Humidity	medium (60%)						
Wind speed	medium (3 m/s)						
Duration of growing period (from sowing): 150 days							
Planting date: 1 February (direct sowing)							

Calculation

Step 1: Estimate the duration of various growth stages, using Table 1.

Crop - Tomatoes
 Planting date – 1 February; harvesting date – 30 June

Initial stage	35 days	1 Feb – 5 Mar
Crop development stage	40 days	6 Mar – 15 Apr
Mid-season stage	50 days	16 Apr – 5 Jun
Late season stage	25 days	6 Jun – 30 Jun

Total	150 days	

Note: When calculating the crop water requirements, all months are assumed to have 30 days.

Step 2: Estimate the Kc factor for each of the 4 growth stages, using Table 2 and bearing in mind that the humidity and wind speed are medium.

Kc, Initial stage	= 0.45
Kc, Crop development stage	= 0.75
Kc, Mid-season stage	= 1.15
Kc, Late season stage	= 0.80

It can be seen that the months and growth stages do not correspond. As a consequence the ETo and Kc values do not correspond.

Yet the ET crop (= ETo x Kc) has to be determined on a monthly basis. It is thus necessary to determine the Kc on monthly basis, which is done as follows:

<u>February</u>	: Kc Feb = 0.45
<u>March</u>	: 5 days : Kc = 0.45
	: 25 days : Kc = 0.75

$$K_c, \text{ Mar} \quad := \frac{5}{30} \times 0.45 + \frac{25}{30} \times 0.75 = 0.07 + 0.62 = 0.69$$

April : 15 days : $K_c = 0.75$
 : 15 days : $K_c = 1.15$

$$K_c, \text{ Apr} \quad := \frac{15}{30} \times 0.75 + \frac{15}{30} \times 1.15 = 0.38 + 0.58 = 0.96$$

Thus $K_c, \text{ Apr} = 0.96$

May : $K_c, \text{ May} = 1.15$

June : 5 days : $K_c = 1.15$
 : 25 days : $K_c = 0.80$

$$K_c, \text{ Jun} \quad := \frac{5}{30} \times 1.15 + \frac{25}{30} \times 0.80 = 0.19 + 0.67 = 0.86$$

Thus $K_c, \text{ Jun} = 0.86$

Step 4: Calculate on a monthly basis the crop water requirements, using the formula:

$$ET \text{ crop} = E_{to} \times K_c \text{ (mm/day)}$$

February : $ET \text{ crop} = 5.0 \times 0.45 = 2.3 \text{ mm/day}$
 March : $ET \text{ crop} = 5.8 \times 0.69 = 4.0 \text{ mm/day}$
 April : $ET \text{ crop} = 6.3 \times 0.96 = 6.0 \text{ mm/day}$
 May : $ET \text{ crop} = 6.8 \times 1.15 = 7.8 \text{ mm/day}$
 June : $ET \text{ crop} = 7.1 \times 0.86 = 6.1 \text{ mm/day}$

Step 5: Calculate the monthly and seasonal crop water requirements.

Note: all months are assumed to have 30 days

February	: $ET \text{ crop} = 30 \times 2.3 =$	69	mm/month
March	: $ET \text{ crop} = 30 \times 4.0 =$	120	mm/month
April	: $ET \text{ crop} = 30 \times 6.0 =$	180	mm/ month
May	: $ET \text{ crop} = 30 \times 7.8 =$	234	mm/ month
June	: $ET \text{ crop} = 30 \times 6.1 =$	183	mm/ month

The crop water requirement for the whole growing season of tomatoes is 786 mm.

5. Irrigation Water Requirements

In section 4, it has been indicated how the crop water requirements (ET crop) is determined. This water can be supplied to the crops in various ways:

- by rainfall
- by irrigation
- by a combination of irrigation and rainfall

In some cases, part of the crop water requirement is supplied by the groundwater through capillary rise. For the purpose of this manual however, the contribution of capillary rise is not taken into account.

In cases where all the water needed for optimal growth of the crop is provided by rainfall, irrigation is not required and the irrigation water requirements (IR) equals zero: $IR = 0$.

In cases where there is no rainfall at all during the growing season, all water must be supplied by irrigation. Consequently, irrigation water requirements (IR) equals the crop water requirement (ET crop): $IR = ET \text{ crop}$.

In most cases, however, part of the crop water need is supplied by rainfall and the remaining part by irrigation. In such cases the irrigation water need (IR) is the difference between the crop water requirements (ET crop) and that part of the rainfall which is effectively used by the plants (Pe). In formula:

$$IR = ET \text{ crop} - P_e$$

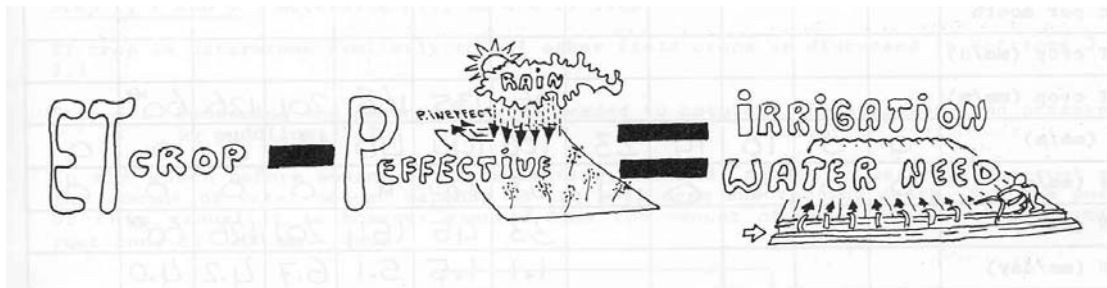

5.1 Effective Rainfall

When rain water falls on the soil surface, part of the rain water percolates below the root zone of the plants and part of the rain water flows away over the soil surface as runoff (Fig. 6). This deep percolation water and runoff water cannot be used by the plants. In other words, part of the rainfall is not effective. The remaining part is stored in the root zone and can be used by the plants. This remaining part is the so-called **effective** rainfall.

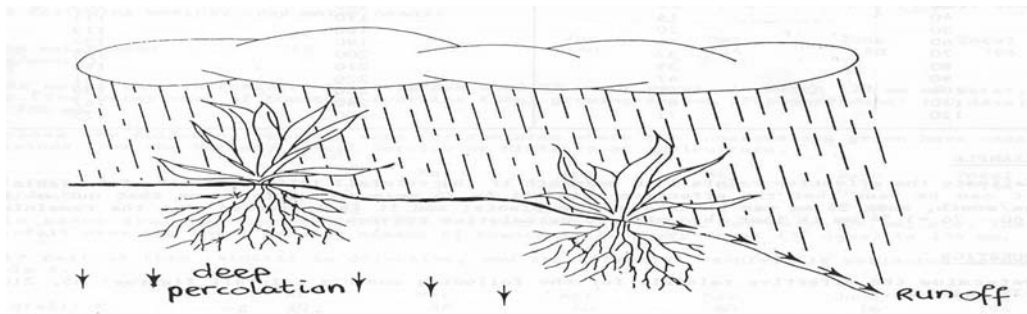

Fig. 6 Part of the rain water is lost through deep percolation and runoff

There are different methodologies to determine the effective rainfall. Effective rainfall varies widely with the local field condition. In many areas, therefore, a local formula is available to estimate effective rainfall. In case there is no local method is available, any of the following methods can be used to estimate effective rainfall.

i) **Fixed percentage of rainfall:** effective rainfall is calculated according to:

$$P_e = a \cdot P_{\text{tot}}$$

Where a is a fixed percentage to be given by the user to account for losses from runoff and deep percolation. Normally losses are around 10 to 30%, thus $a = 0.7 - 0.9$.

ii) Following formulae can also be applied:

$$P_e = 0.8 P_{\text{tot}} - 24 \quad \text{if } P_{\text{tot}} > 70 \text{ mm/month}$$

$$P_e = 0.6 P_{\text{tot}} - 10 \quad \text{if } P_{\text{tot}} < 70 \text{ mm/month}$$

P_{tot} = rainfall or precipitation (mm/month)
 P_e = effective rainfall (mm/month)

5.2 Irrigation Requirement of Upland Crops or Non-rice crops

For all field crops except rice, the irrigation water requirement (IR) is determined as follows:

- Step 1 : Determine the reference crop evapotranspiration, ET_o
- Step 2 : Determine the crop factors, K_c
- Step 3 : Calculate the crop water requirements, $ET_{\text{crop}} = ET_o \times K_c$
- Step 4 : Determine the effective rainfall, P_e
- Step 5 : Calculate the irrigation water requirements, $IR = ET_{\text{crop}} - P_e$

Example 4: Determine the irrigation water requirement (IR) for crop in example 3.

Given: Monthly rainfall

Month	Jan	Feb	Mar	Apr	May	Jun	Jul
Rainfall (mm/month)	12	34	79	106	109	128	99

Effective rainfall = 80% of total monthly rainfall

Calculation:

Pe for the month of February	= 34 x 0.80	= 27.2 mm
Pe for the month of March	= 79 x 0.80	= 63.2 mm
Pe for the month of April	= 106 x 0.80	= 84.8 mm
Pe for the month of May	= 109 x 0.80	= 87.2 mm
Pe for the month of June	= 128 x 0.80	= 102.4 mm

$IR = ET_{\text{crop}} - P_e$

IR (February)	=	69 – 27.2	= 41.8 mm
IR (March)	=	120 – 63.2	= 56.8 mm
IR (April)	=	180 – 84.8	= 95.2 mm
IR (May)	=	234 – 87.2	= 146.8 mm
IR (June)	=	183 – 102.4	= 80.6 mm

Total irrigation requirements = 421.2 mm

5.3 Irrigation Water Requirements of Rice

Paddy rice, growing with “its feet in the water”, is an exception. Not only does the crop water requirement (ET crop) need to be supplied by irrigation or rainfall, but also water is needed for:

- Nursery and land preparation before transplanting or land preparation for direct sowing and
- Seepage and deep percolation.

Therefore, irrigation requirements for rice can be estimated by the following equation:

$$IR \text{ rice} = ET \text{ rice} + NR + LR + SP - Pe$$

Where,

- IR rice = Irrigation water requirements of rice
- ET rice = Crop water requirements of rice
- NR = Nursery requirement
- LR = Nursery and land preparation requirement
- SP = Seepage and percolation
- Pe = Effective rainfall.

Water required for nursery and land preparation (or for land preparation only in case of direct sowing) is added to the field before transplanting or sowing with in a short time (usually a month) by 2-3 applications. The total requirement is therefore added during the first month of the rice cultivation. The amount of water required for nursery and/or land preparation depends on the field condition (soil type, initial soil moisture contents, etc.) and varies between 200 to 300 mm.

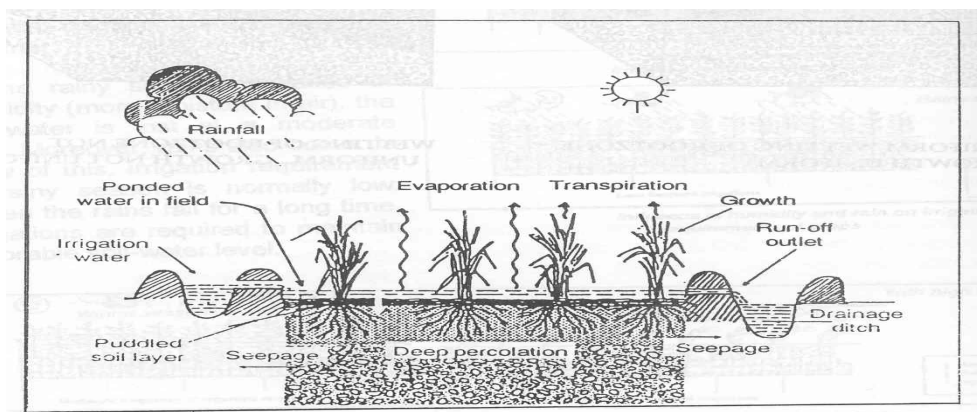

Fig. 7 Water balance in the paddy field

Once rice is transplanted (or direct sown), the irrigation requirements are estimated using the following formula:

$$IR \text{ rice} = ET \text{ rice} + SP - Pe.$$

The percolation and seepage losses depend on the type of soil. They will be low in very heavy, well-puddled clay soils and high in the case of sandy soils. The percolation and seepage losses vary between 1-8 mm/day.

Usually, local values of percolation rate are known by the irrigation or agricultural departments. If not, standard values available based on the soil type can be used. Percolation rate can also be estimated in the field using the infiltrometer. The water balance in the paddy field is shown in Fig. 7.

Example 5: Determine the irrigation water requirements for rice

Given:

Month	May	Jun	Jul	Aug	Sep	Oct	Nov	Dec
ET _o (mm/day)	7.6	6.8	5.7	5.5	4.9	4.3	3.6	3.4
Rainfall (mm/month)	49	79	106	109	128	99	26	2

Nursery requirement, NR (1 month during June) = 70 mm

Land preparation requirement, LR (1-10 July) = 180 mm

Date of transplanting 10 July

Seepage and percolation rate = 3mm/day

Effective rainfall = 80% of the total rainfall (on monthly basis)

Initial stage	= 20 days	K _c	=	1.10
Crop development stage	= 30 days	K _c	=	1.08
Mid-season stage	= 40 days	K _c	=	1.05
Late season stage	= 30 days	K _c	=	0.80

Calculation:

Step 1: Determine the crop factor

Initial stage	= 20 days	July 10 – July 30
Crop development stage	= 30 days	August 01 – August 30
Mid-season stage	= 40 days	September 01 – October 10
Late season stage	= 30 days	October 11 – November 10

(Note: Each month was considered as 30 days.)

The ET crop (= ET_o x K_c) should be determined on a monthly basis. It is thus necessary to determine the K_c on monthly basis, which is done as follows:

July : 20 days : K_c, Jul = 1.10

August : K_c, Aug = 1.08

September : Kc, Sep = 1.05

October : 10 days : Kc = 1.05
: 20 days : Kc = 0.80

$$Kc, Oct = \frac{10}{30} \times 1.05 + \frac{20}{30} \times 0.80 = 0.35 + 0.53 = 0.88$$

Thus Kc, Oct = 0.88

November : 10 days : Kc, Nov = 0.80

Step 2: Calculate on a monthly basis the crop water requirement, using the formula:

$$ET \text{ crop} = Eto \times Kc \text{ (mm/day)}$$

July : ET crop = 5.7 x 1.10 = 6.3 mm/day
August : ET crop = 5.7 x 1.08 = 6.2 mm/day
September : ET crop = 4.9 x 1.05 = 5.1 mm/day
October : ET crop = 4.3 x 0.88 = 3.8 mm/day
November : ET crop = 3.6 x 0.80 = 2.9 mm/day

Step 3: Calculate the monthly and seasonal crop water requirements.

Note: all months are assumed to have 30 days

July	:	ET rice = 20 x 6.3	=	126	mm/month
August	:	ET rice = 30 x 6.2	=	186	mm/month
September	:	ET rice = 30 x 5.1	=	153	mm/ month
October	:	ET rice = 30 x 3.8	=	114	mm/ month
November	:	ET rice = 10 x 2.9	=	29	mm/ month

(Note: Date of transplant is 10 July. Date of harvest is 10 November. Therefore, 20 days for July and 10 days for November.)

Step 4: Calculate the effective rainfall and seepage and percolation

Effective rainfall:

June	:	79 x 0.80	=	63.2 mm = 63 mm
July	:	106 x 0.80	=	84.8 mm = 85 mm
August	:	109 x 0.80	=	87.2 mm = 87 mm
September	:	128 x 0.80	=	102.4 mm = 102 mm
October	:	99 x 0.80	=	79.2 mm = 79 mm
November	:	26 x 0.80	=	20.8 mm = 21 mm

Seepage and percolation:

July	:	3 x 20 = 60.0 mm
August	:	3 x 30 = 90.0 mm

September : 3 x 30 = 90.0 mm
 October : 3 x 30 = 90.0 mm
 November : 3 x 10 = 30.0 mm

(Note: Seepage and percolation during the nursery and land preparation period is considered with the nursery and land preparation requirements.)

Step 5: Estimate the monthly irrigation requirement

June: IR rice, Jun = ET rice + NR + LR + SP – Pe = 0 + 70 + 0 – 63 = 8 mm
 (ET rice and SP are zero in the month of June)

July: IR rice, Jul = ET rice + LR + SP – Pe = 126 + 180 + 85 – 60 = 331 mm

August: IR rice, Aug = ET rice + SP – Pe = 186 + 90 – 87 = 189 mm

September: IR rice, Sep = ET rice + SP – Pe = 153 + 90 – 102 = 141 mm

October: IR rice, Oct = ET rice + SP – Pe = 114 + 90 – 79 = 129 mm

November: IR rice, Nov = ET rice + SP – Pe = 29 + 30 – 21 = 38 mm

Seasonal irrigation requirements = 8 + 331 + 189 + 141 + 129 + 38 = 836 mm

5.4 Irrigation Efficiency

The irrigation requirements estimated in examples 4 and 5 above, are the net irrigation required for the crop. This means this amount of water should be available for the crop. While applying water to the field, usually, not all, of the amount of water is available. Some amount of water moves to the other field or percolates beyond the crop root zone hence, it is not available for plant.

Therefore, in order to have the net required depth available for the crop, an extra amount of water must be provided to cover the losses in applying and conveying water to the field. The overall efficiency of the irrigation system or project, therefore, can be expressed as:

$$\text{Overall Efficiency, } E_p = \frac{\text{Water directly available to the crop}}{\text{Water released from the source (reservoir or river)}}$$

The overall efficiency of an irrigation canal is too broad to be useful in irrigation system design and management. It is normally subdivided into 3 levels, each of which is affected by a different set of conditions. These are:

- a) Conveyance efficiency (E_c): ratio between water received at inlet to a block of fields and that released at the project headworks.
- b) Field canal efficiency (E_b): ratio between water received at the field inlet and that received at the inlet of the block of fields.
- c) Field application efficiency (E_a): ratio between water directly available to the crop and that received at the field inlet.

Thus, the overall efficiency or project efficiency, $E_p = E_c \times E_b \times E_a$.

Conveyance and field canal efficiency are sometimes combined as distribution efficiency (E_d).

Factors affecting conveyance efficiency (E_c) are:

- size of irrigation acreage,
- size of rotational unit,
- number and types of crops requiring adjustment in the supply,
- canal lining, and
- the technical and managerial facilities of water control.

The field canal efficiency (E_b) is affected by:

- the method and control of operation,
- the type of soil in respect of seepage losses,
- length of field canals,
- size of the irrigation block and the fields.

Water losses can be high during field application. Low application efficiency (E_a) will occur when rate of water applied exceeds the infiltration rate and excess is lost by runoff. When the depth of water applied exceeds the storage capacity of the root zone, the excess is lost by deep drainage. With surface irrigation, field layout and land grading is most essential; uneven distribution of water will cause drainage losses in one part and possibly under-irrigation in the other parts of the field, resulting in very low water use efficiency. E_a may vary during the growing season with highest efficiencies during peak water use periods. E_a also varies with crop to crop.

In estimating the gross irrigation requirement (net irrigation requirements plus losses) it is advisable to use the locally available or estimated efficiency values. Standard values of efficiencies which can be used if no other data are available are given in Table A.3 of the appendix.

Example 6: What are the monthly irrigation requirements of example 5 if,

Conveyance efficiency (E_c) = 0.70
Field canal efficiency (E_b) = 0.80
Field application efficiency (E_a) = 0.85

Calculation:

Overall efficiency or project efficiency (E_p) = $E_c \times E_b \times E_a = 0.70 \times 0.80 \times 0.85 = 0.48$

Therefore, $E_p = 0.40$ (approx.)

June: IR rice, Jun	= 8 /0.40	= 20 mm
July: IR rice, Jul	= 331/0.40	= 828 mm
August: IR rice, Aug	= 189/0.40	= 473 mm
September: IR rice, Sep	= 141/0.40	= 353 mm

October: IR rice, Oct = 129/0.40 = 323 mm
 November: IR rice, Nov = 38/0.40 = 95 mm

Seasonal irrigation requirements = 20 + 828 + 473 + 353 + 323 + 95 = 2092 mm

5.5 Cropping Pattern and Crop Information

The irrigation requirements shown in the previous section estimates the requirements for a particular field. But in irrigation project or scheme there are several crops which are grown at different times. To estimate the irrigation requirements for the total area we need to know information on the various crop characteristics such as length of the growth cycle, etc.

Essential information collected from the field should include:

- Crop and crop variety
- First and last planting date
- First and last harvesting date
- Area under each crop

The collected information on the planting and harvest dates should be systematically arranged in a cropping pattern.

The planting date of crops, in particular those which cover substantial areas or are high in water demand, such as rice, may be spread over a period of 3-6 weeks. In such cases the crop may be subdivided into different crop units with planting date intervals of 10-15 days.

Table 3 provides an example of the different crop information to be collected for each crop and crop type necessary to estimate the scheme irrigation requirements. Fig. 8 illustrates a possible distribution of crops over the year and over the irrigated area.

Table 3 Cropping calendar

No.	Crop	Area (%)	Planting dates	Harvest dates
1	Paddy	13	10 Jul	10 Nov
2	Paddy	12	20 Jul	20 Nov
3	Paddy	13	1 Aug	1 Dec
4	Paddy	12	10 Aug	10 Dec
5	Paddy	7	10 Dec	10 Apr
6	Paddy	6	20 Dec	20 Apr
7	Paddy	7	1 Jan	1 May
8	Cotton	15	1 Aug	1 Feb
9	Groundnut	6	15 Jul	5 Nov
10	Groundnut	7	1 Aug	20 Nov
11	Groundnut	7	15 Aug	5 Dec
12	Groundnut	20	15 Dec	5 Apr
13	Groundnut	20	1 Jan	20 Apr
14	Groundnut	20	15 Jan	5 May
15	Sorghun	5	15 Jul	15 Nov
16	Sorghun	5	1 Aug	1 Dec
17	Sugarcane	5	1 Jan	1 Jan

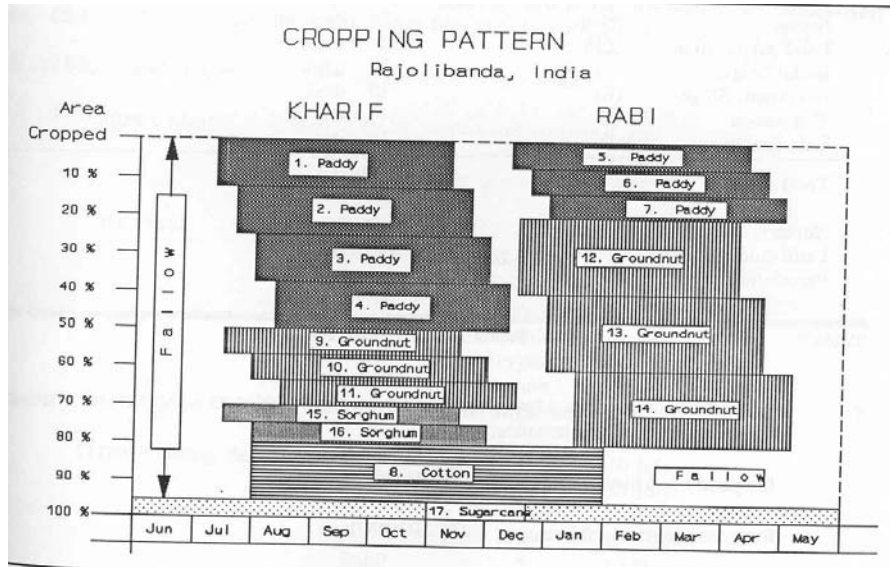

Fig. 8 Example of a cropping pattern

There are two seasons in the area: Wet Season and Dry Season. Four crops are grown in the wet season: paddy, groundnut, sorghum and Cotton. There are two crops in the dry season: paddy and groundnut. Sugarcane is grown throughout the year. In the Table 3 or Fig. 8 paddy (No.1 to 4) is the same crop, just planted 10 days apart. Practically, all the farmers in an area do not transplant the crop on the same day. Some farmer plant early and some farmer plant late. This staggered planting schedule is shown in the Table and Figure above, considering each a separate crop for easy understanding and estimation of irrigation requirements.

5.6 Scheme Irrigation Requirements

In example 3, 4, 5 and 6 above, we have estimated the monthly irrigation requirements of paddy and tomatoes. Following the same procedure, we have to estimate the monthly irrigation requirements of each crop based on the cropping pattern and crop calendar. The total monthly requirements will then be determined by summing up the monthly irrigation requirements for all crops.

Example 7: Assume an irrigation project having a total cultivable area of 100 ha. The crop calendar and cropping pattern are as given in Table 3 and Fig.6.

Estimate the monthly flow requirement in the canal.

Calculation:

Step 1: Estimate the ET for each crop

Step 2: Estimate the irrigation requirement (IR) of each crop separately as shown in Example 5.

Irrigation requirements of the crops on monthly basis are shown in the Table 4.

Table 4 Monthly irrigation requirements of different crops

Crop No.	Crop name	Irrigation requirement (mm)												Total (mm)
		Jan	Feb	Mar	Apr	May	Jun	Jul	Aug	Sep	Oct	Nov	Dec	
1	Paddy 1						134	262	177	144	122	28		867
2	Paddy 2						260	298	180	144	140	74		1096
3	Paddy 3							259	181	146	146	130		862
4	Paddy 4							127	249	148	146	154	36	860
5	Paddy 5	215	239	244	60							128	267	1153
6	Paddy 6	216	240	263	136							25	305	1185
7	Paddy 7	217	241	271	223								263	1215
8	Cotton								0	30	50	98	105	283
9	Groundnut 1							0	16	44	40	7		107
10	Groundnut 2								0	26	49	43		118
11	Groundnut 3								0	5	48	79	11	143
12	Groundnut 4	58	139	158	21								10	386
13	Groundnut 5	28	118	170	101									417
14	Groundnut 6	12	69	169	171	21								442
15	Sorghum 1							0	14	57	58	21		150
16	Sorghum 2								0	27	69	69		165
17	Sugarcane	110	135	164	178	178	129	80	67	39	44	82	95	1301

Step 3: Determine the area under each crop

Total area = 100 ha

Table 5: Area under each crop

No.	Crop	Area (ha)
1	Paddy	13
2	Paddy	12
3	Paddy	13
4	Paddy	12
5	Paddy	7
6	Paddy	6
7	Paddy	7
8	Cotton	15
9	Groundnut	6
10	Groundnut	7
11	Groundnut	7
12	Groundnut	20
13	Groundnut	20
14	Groundnut	20
15	Sorghun	5
16	Sorghun	5
17	Sugarcane	5

Step 4: Estimate the monthly water volume required for each crop using the formula:

$$\text{Volume of water (m}^3\text{)} = 10 \times \text{Area (ha)} \times \text{Depth of irrigation (mm)}$$

(Note: 10 is the conversion factor from ha-mm to m³, 1 ha-mm = 10 m³
 For example: Volume of water for paddy 1 in June = 10 x 13 x 134 = 17,420 m³)

Using this formula, the monthly volume of water required for each crop is as shown in Table 6.

Table 6 Monthly volume of water required for each crop

Crop No.	Crop name	Irrigation requirement, (000 m ³)											
		Jan	Feb	Mar	Apr	May	Jun	Jul	Aug	Sep	Oct	Nov	Dec
1	Paddy 1						17.4	34.1	23.0	18.7	15.9	3.6	
2	Paddy 2						31.2	35.8	21.6	17.3	16.8	8.9	
3	Paddy 3							33.7	23.5	19.0	19.0	16.9	
4	Paddy 4							15.2	29.9	17.8	17.5	18.5	4.3
5	Paddy 5	15.1	16.7	17.1	4.2							9.0	18.7
6	Paddy 6	13.0	14.4	15.8	8.2							1.5	18.3
7	Paddy 7	15.2	16.9	19.0	15.6								18.4
8	Cotton								0.0	4.5	7.5	14.7	15.8
9	Groundnut 1							0.0	1.0	2.6	2.4	0.4	
10	Groundnut 2								0.0	1.8	3.4	3.0	
11	Groundnut 3								0.0	0.4	3.4	5.5	0.8
12	Groundnut 4	11.6	27.8	31.6	4.2								2.0
13	Groundnut 5	5.6	23.6	34.0	20.2								
14	Groundnut 6	2.4	13.8	33.8	34.2	4.2							
15	Sorghum 1							0.0	0.7	2.9	2.9	1.1	
16	Sorghum 2								0.0	1.4	3.5	3.5	
17	Sugarcane	5.5	6.8	8.2	8.9	8.9	6.5	4.0	3.4	2.0	2.2	4.1	4.8
Total		68	120	159	95	13	55	123	103	88	94	91	83
Flow, lit/s		26	46	62	37	5.1	21	47	40	34	36	35	32

Therefore, we need 68,000 m³ of water in January, 120,000 m³ in February and so on.

Considering the continuous flow in the canal the flow requirement is:

Flow required in the canal (m³/s) = Volume of water / time

Flow required in January = (68,000 / (30 x 24 x 3600)) = 0.026 m³/s = 26 lit/s

If the irrigation efficiencies are:

Conveyance efficiency (E_c) = 0.70

Field canal efficiency (E_b) = 0.80

Field application efficiency (E_a) = 0.70

Then overall efficiency or project efficiency (E_p) = E_c x E_b x E_a = 0.70 x 0.80 x 0.70 = 0.39 = 0.40 (approx.).

Flow requirement for January = 0.26/0.40 = 65 lit/sec.

Similarly flow requirements for the other months can be estimated.

6. On-Farm Water Management

On farm water management signifies utilization of every unit of water economically, to obtain optimum production. The aim is to provide just adequate quantity of irrigation water, and secure saving in water and labor.

On-farm water needs are related to soil, crop, and climate.

6.1 Soils

Soil is made up of different sized particles. They are sand, silt and clay, which are held together loosely leaving small spaces (pores) between them. Water and air are held in these pores.

A soil is classified by the amount of sand, silt and clay particles it contains. This will give you an idea about the type of soil. The intake of water, the capacity to hold water and drain water depends on the type of soil.

The common terms used by the farmers to identify different soils are:

Light soil	:	Sandy, Sandy loams
Medium soil	:	Sandy clay loam
Heavy soil	:	Clay soils

Light soils have more sand and less silt and clay. They are easy to cultivate but less fertile. They retain less water and drain quickly.

Medium soils have balanced amounts of sand, silt and clay. They retain moderate quantity of water, generally they are well drained. Fertility status is usually low.

Heavy soils or fine soils have more clay and less sand and silt. They are difficult to cultivate but retain high amounts of water and drain very poorly. Heavy soils hold two to three times more water than light soils. Hence, on heavy soils irrigations are applied at longer intervals. The amount of water per irrigation would also be higher for heavy soils.

Application of farmyard manure, cattle manure or compost improves the water holding capacity of soils. It also improves the drainage of heavy soils. Depth of soils also directly influences the water holding capacity of soils. Deeper the soil, more water is held in it which can be available to the plants.

FWUC members and the staff of the Department of Irrigated Agriculture should know the water holding capacity of the soils, so that they can apply the right amount of water at each irrigation. Any irrigation water added in excess of the soil's capacity is lost through deep drainage. Continued application of excess irrigation is harmful, because:

1. It results in the loss of nutrients (fertilizer) from soils;
2. It damages the soil due to water stagnation and salinity; and

3. It damages the crops due to poor aeration.

6.2 Crop Factors

The crop growth is normal till the soil-water content in the root zone is within favorable limits, below which the growth will start getting affected. When the soil water content is very low, the plants stop growing or die. This is the lowest limit of available soil-water for plant survival. However, need not wait till that stage but irrigate whenever the water content in soil is still within favorable limits.

The favorable soil-water limits differ from different crops. In general, crops grown for their fresh leaves or fruits are more sensitive to water shortages than those grown for their dry seeds or fruits. Table 7 shows four categories of crops; the categories are based on the sensitivity of the specific crops to drought.

Table 7 Sensitivity of Various Field Crops to Water Shortages

Sensitivity	Low	Low-Medium	Medium-High	High
Crops	cassava	alfalfa	beans	banana
	cotton	citrus	cabbage	fresh green
	millet	grape	maize	vegetables
	pigeon pea	groundnuts	onion	paddy rice
	sorghum	soybean	peas	potato
		sugarbeet	pepper	sugarcane
		sunflower	tomato	
		wheat	(water) melon	

As can be seen from the above table, crops like paddy rice, banana, potato and sugarcane are very sensitive to water shortages. This means that if they suffer - even little - water shortages, their yields will be reduced considerably; such water shortages must be avoided.

Crops like millet and sorghum, on the other hand, are only slightly sensitive to drought; they are drought resistant. If the water shortage does not last too long, the effect on the yield will be minimal. If various crops are grown on an irrigation scheme, e.g. groundnuts and lettuce (fresh green vegetables), and water is short in supply, it is advisable to give priority to irrigating the most drought sensitive crop; in this case lettuce.

6.2.2 Which Growth Stages are Sensitive to Water Shortages

The total growing season of an annual crop can be divided into four growth stages as discussed and explain in Section 4.

- the initial stage; from sowing to 10% ground cover
- the crop development stage; from 10% to 70% ground cover
- the mid-season stage; including flowering and grain setting or yield formation
- the late season stage; including ripening and harvest.

In general it can be stated that of the four growth stages, the mid-season stage is most sensitive to water shortages. This is mainly because it is the period of the highest crop water needs. If water shortages occur during the mid-season stage, the negative effect on the yield will be pronounced.

The least sensitive to water shortages is the late season stage. This stage includes ripening and harvest. Water shortages in this stage have - especially if the crop is harvested dry - only a slight effect on the yield. Care should, however, be taken even during this stage with crops which are harvested fresh, such as lettuce. Fresh harvested crops are also sensitive to water shortages during the late season stage.

The initial and crop development stages are between the mid-season and late season stages with respect to sensitivity to water shortages. Some crops react favorably to water shortage during the crop development stage: they react by developing a deeper root system, which is helpful during the later stages. Table 8 indicates the growth stages most sensitive to water shortages for various important field crops.

Table 8 Periods Sensitive to Water Shortages

Crop	Sensitive period
Banana	throughout
Bean	flowering and pod filling
Cabbage	head enlargement and ripening
Citrus	flowering and fruit setting more than fruit enlargement
Cotton	flowering and boll formation
Grape	vegetative period and flowering more than fruit filling
Groundnut	flowering and pod setting
Maize	flowering and grain filling
Onion	bulb enlargement
Onion (for seed prod.)	flowering
Pea/fresh	flowering and yield formation
Pea/dry	ripening
Pepper	throughout
Pineapple	vegetative period
Potato	stolonization and tuber initiation
Rice	head development and flowering
Sorghum	flowering and yield formation
Soybean	flowering and yield formation
Sugarcane	vegetative period (tillering and stem elongation)
Sunflower	flowering more than yield formation
Tomato	flowering more than yield formation
Watermelon	flowering and fruit filling
Wheat	flowering more than yield formation

On an irrigation project, if only one crop is grown, but not all fields have been planted at the same time (staggered planting), and water is in short supply, it is advisable to give priority to irrigating those fields on which the crop has reached the mid-season stage (flowering and yield formation).

6.2.3 Cropping Pattern in Relation to Water Availability

As discussed in Section 5.6 and showed in Example 7, the flow requirement in the canal depends on the cropping pattern. It is important that the availability of water is adequate to meet the requirements. Otherwise, the crops will suffer water stress and the yield will be reduced as discussed above (Section 6.2.1 and 6.2.2). If the availability of water is less than the required in the system then we call the system is under scarcity condition.

Scarcity conditions can be effectively tackled through change of crops and cropping pattern. Choice of an alternative crop is possible, as certain crops require comparably low quantity of water.

Crop options are, however, possible only when the scarcity condition is known in advance as in the case of dry season or at least during the sowing/planting period in the case of wet season. During scarcity conditions, irrigation deliveries are rescheduled to suit the changed cropping pattern at aggregate level.

The risk of crop production due to uncertain nature of scarcity in the dry season can also be reduced by growing crops, which tolerate stress. It is not advisable to grow rice if there is a possibility of water scarcity. Rice requires more and cannot tolerate stress. Instead of growing rice other upland crops should be cultivated.

6.3 Climate Factors

Climate plays a predominant role in determining the water needs of any crop. The influence of climate on crop water requirements are already discussed Section 4. The important climatic factors which influence the rate of water loss from cropped fields are sunlight, temperature, humidity and wind. In summer, because of heat and dryness, the soil-water in the cropped field is lost faster. Hence, frequent irrigations are required in summer.

In the rainy season, because of humidity the soil-water is lost at a moderate rate. Moreover, rains also occur. In view of this, irrigation requirement in rainy season is normally low.

In winter, because of low temperature, the soil-water loss is slower. The irrigation intervals are, therefore, longer.

In high winds, evaporation is high. The crops use more water. Hence, more irrigation is required.

6.4 Irrigation Schedule for Crops other than Rice

The accurate determination of an irrigation schedule is a time-consuming and complicated process. The introduction of computer programs (e.g. CROPWAT), however, has made it easier and it is possible to schedule the irrigation water supply exactly according to the water needs of the crops. Ideally, at the beginning of the growing season, the amount of water given per irrigation application, also called the irrigation depth, is small and given frequently. This is due to the low evapotranspiration of the young plants and their shallow root depth. During the mid season, the irrigation depth should be larger and given less frequently due to high evapotranspiration and maximum root depth. Thus, ideally, the irrigation depth and/or the irrigation interval (or frequency) vary with the crop development.

When surface irrigation methods are used, however, it is not very practical to vary the irrigation depth and frequency too much. With, in particular, surface irrigation, variations in irrigation depth are only possible within limits. It is also very confusing for the farmers to change the schedule all the time. Therefore, it is often sufficient to estimate or roughly calculate the irrigation schedule and to fix the most suitable depth and interval; in other words, to keep the irrigation depth and the interval constant over the growing season.

The table (Table 9) is provided to estimate the irrigation schedule for the major field crops during the period of peak water demand; the schedules are given for three different soil types. The table is based on calculated crop water needs and an estimated root depth for each of the crops under consideration. The table assumes that with the irrigation method used the maximum possible net application depth is 70 mm.

With respect to soil types, a distinction has been made between sand, loam, and clay, which have, respectively, a low, a medium, and a high available water content. With respect to climate, a distinction is made between three different climates.

Table 9 Irrigation Schedule for the Major Field Crops

Shallow and/or sandy soil	In a sandy soil or a shallow soil (with a hard pan or impermeable layer close to the soil surface), little water can be stored; irrigation will thus have to take place frequently but little water is given per application.
Loamy soil	In a loamy soil more water can be stored than in a sandy or shallow soil. Irrigation water is applied less frequently and more water is given per application.
Clayey soil	In a clayey soil even more water can be stored than in a medium soil. Irrigation water is applied even less frequently and again more water is given per application.

It is important to note that the irrigation schedules given in Table 9 are based on the crop water needs in the peak period. It is further assumed that little or no rainfall occurs during the growing season.

In summary, in order to save water, it may be feasible to irrigate, during the early stages of the crop development, with smaller irrigation applications than during

the peak period. During the late season stage it may be feasible to irrigate less frequently, in particular if the crop is harvested dry.

When adjusting the irrigation schedule for the non-peak periods, it should always be kept in mind that the irrigation schedules must be simple, in particular in surface irrigation schemes where many farmers are involved. It will often be necessary to discuss with the farmers, before implementing the irrigation schedule, the various alternatives and come to an agreement which best satisfies all parties involved.

6.5 Irrigation Schedule for Paddy Rice

Paddy rice is usually grown in level basins (Figure 9) which are flooded with water throughout most of the growing season.

The main reason for flooding the rice fields is that most rice varieties maintain better growth and produce higher yields when grown in flooded soils, than when grown in dry soils. The water layer also helps to suppress the weeds.

To grow a paddy rice crop, the following activities are usually carried out:

1. Preparation of the rice nursery

The nursery is usually 5 - 10% of the size of the total area to be planted; for example, if the total field size is 1200 m², then the nursery should be between (0.05 x 1200 =) 60m² and (0.10 x 1200 =) 120 m².

Preparation of the nursery starts one month before sowing the nursery. The soil of the nursery should be loose, without weeds, moist and fertile. When sowing the nursery, it is very important to select good rice seeds.



Fig. 9 Rice Cultivated in a Level Basin

2. Preparation of the rice fields

Preparation of the rice fields starts about one, or sometimes two, months before the rice is transplanted. The fields are usually first flooded. A few days after

flooding, the field is ploughed. Ploughing is the initial breaking and turning over of the soil. Flooding makes ploughing easier. Ploughing is done by hand (with a hoe), by animal traction or mechanically.

It is also possible to plough the dry soil; this is, however, much heavier and is in practice only done if tractors are available. Ploughing the dry soil does save some water.

After ploughing, the soil is puddled. During puddling, the big soil clods are broken. Puddling reduces the permeability of the soil and therefore also reduces the percolation losses.

After puddling, the soil is leveled; that is, the soil is made flat. To facilitate the leveling, the soil is flooded with a shallow water layer. This way it is possible to see where the high spots are. Leveling can be done with a shovel, a rake, a leveling board, etc.

3. Transplanting of the seedlings

The seedlings should be transplanted approximately one month after sowing the nursery. The seedlings will then have four to five leaves. Only strong seedlings are transplanted. The seedlings must be transplanted into the very wet rice field. The seedlings are planted in straight rows with proper spacing between them.

6.5.1 Rice Growth Stages

Usually a distinction is made between the four growth stages of rice (Figure 10).

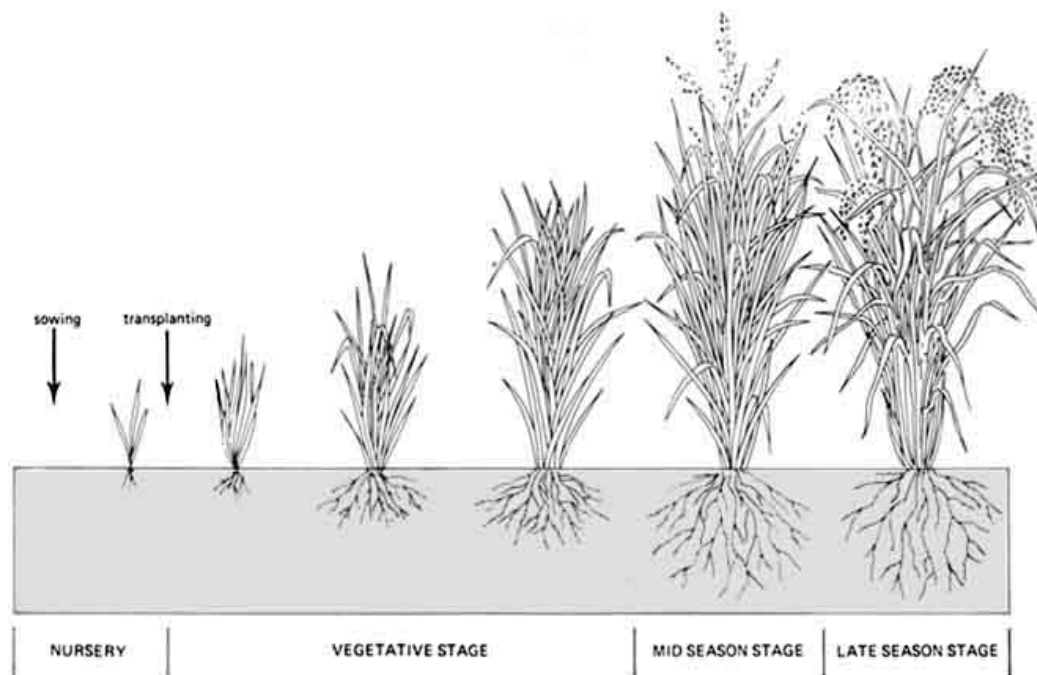

Fig. 10 Growth Stages of Rice

Nursery:	from sowing to transplanting; duration approximately one month.
Vegetative stage:	from transplant to panicle initiation; duration varies from 1½ to 3 months. Vegetative stage includes the tillering. Tillering means that several stems develop on one plant (Figure 10). If the rice is sown directly (broadcast), the two stages combined are called the vegetative stage.
Mid season or reproductive stage:	from panicle initiation to flowering; duration approximately one month. This stage includes stem elongation, panicle extension and flowering. Late tillers may die.
Late season or ripening stage:	from flowering to full maturity; duration approximately one month. This stage includes grain growth.

6.5.2 Irrigation Water Need of Rice

The determination of the irrigation water need of rice has been explained in Section 5.

For rice, a water layer is established after transplanting. The amount of water needed for maintaining the water layer has already been taken into account with the determination of the percolation and seepage losses. The amount of water needed to establish the water layer, however, still has to be considered. Various approaches are being used with respect to the depth of the water layer. Sometimes a water layer of 100 mm is established after transplant and maintained throughout the growing season. In other cases the water layer is reduced to 20 to 50 mm during the latter part of the vegetative stage and brought back to 100 mm during the mid-season stage.

Also a common practice is to drain all the water from the field before applying fertilizers and to re-establish the water layer after the fertilizer application. This, of course, has a significant effect on the total irrigation water need of rice.

6.6 Conjunctive Use of Water

One of the major problems faced in surface irrigation systems has been shortage of water. To minimize some of these problems normally encountered in surface irrigation systems and to meet the normal requirements of irrigation for good crop production, exploitation and utilization of groundwater resources within the command area along with water supplies from the system is adopted. This is called “**Conjunctive Use of Water**”. Optimum development of water resources can be achieved by the conjunctive use of surface water and groundwater.

6.6.1 Benefit from Conjunctive Use of Water

The benefits accruing from the conjunctive use of water are:

- i. Provides water supplies during times of drought or delayed supplies;
- ii. Throughout the crop period water requirements of the crop can be ensured;
- iii. When the surface water is not available groundwater supplies meet the demands and thus enhances crop intensity and provides additional income;

- iv. Water logging in the canal irrigated areas can be controlled by pumping from wells;
- v. Both water conservation and flood protection can be achieved simultaneously;
- vi. Efficient water use is achieved from wells due to smaller surface distribution system as compared to canal irrigation scheme;
- vii. The crop season can be in time or even advanced, prior to the availability of surface water;
- viii. Provide late watering when surface water is not available; and
- ix. Permits better flexibility in cropping pattern.

7. Irrigation System

An irrigation system normally consists of a (main) intake structure or (main) pumping station, a conveyance sub-system, a distribution sub-system, a field application sub-system, and a drainage sub-system (Fig. 11).

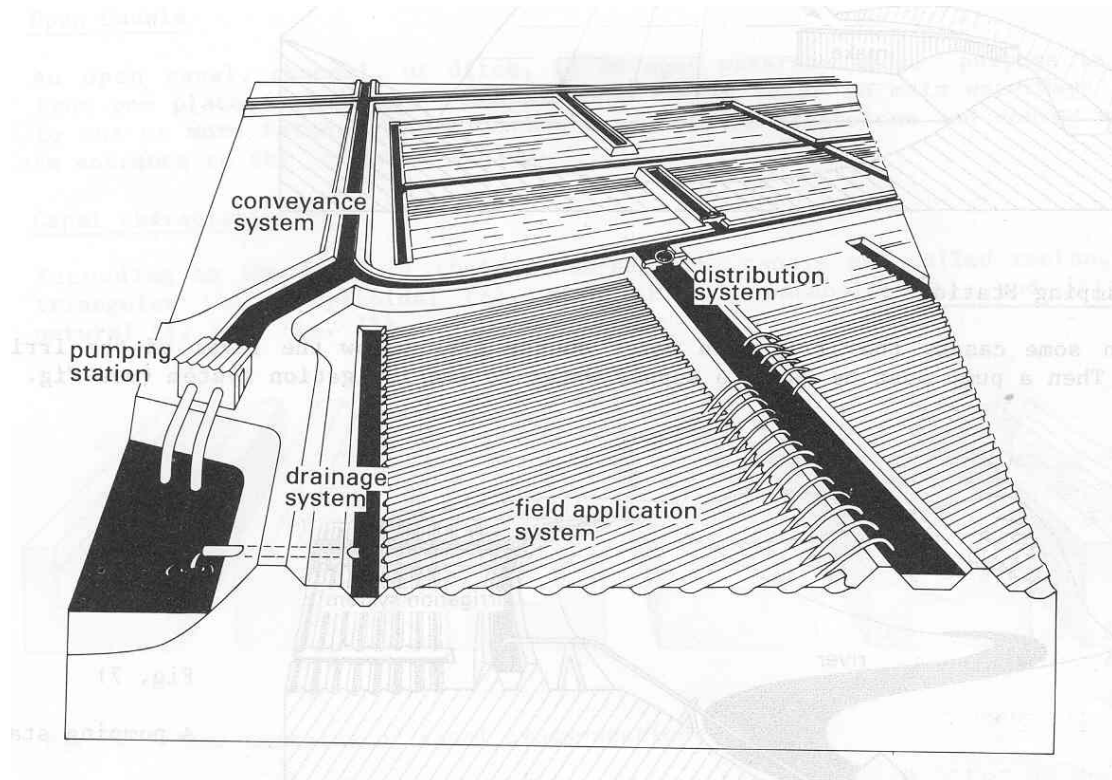

Fig. 11 An irrigation system

7.1 Intake Structure or Pumping Station

The (main) intake structure, or (main) pumping station, directs water from the source of supply, such as a reservoir or a river, into the irrigation system. The intake structure is built at the entry to the irrigation system (Fig. 12).

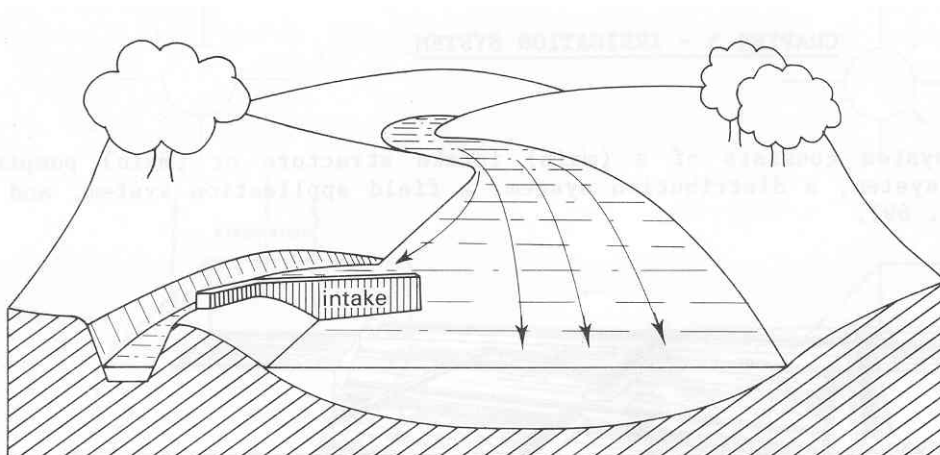

Fig. 12 An intake structure

In some cases, the irrigation water source lies below the level of the irrigated fields. Then a pump station must be used to supply water to the irrigation system (Fig. 13).

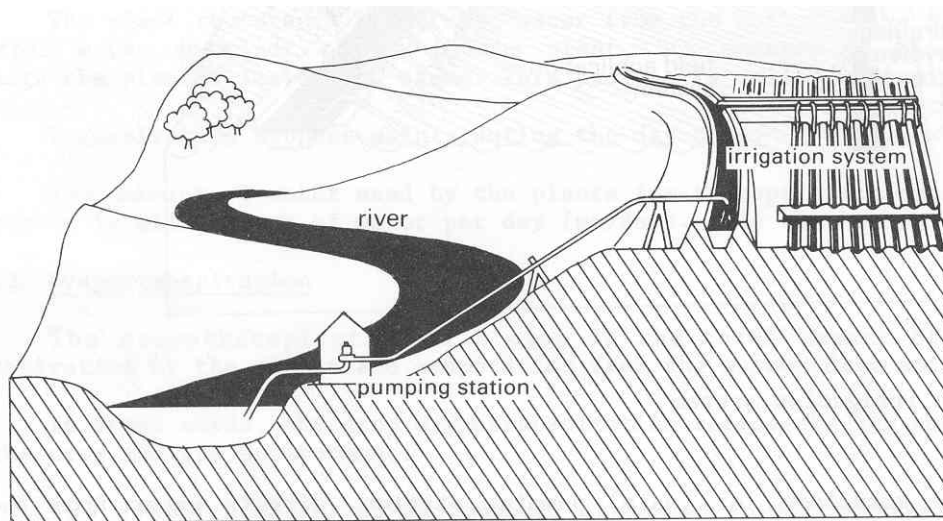

Fig. 13 A pumping station

7.2 Conveyance and Distribution System

The conveyance and distribution system consist of canals transporting the water through the whole irrigation system. Canal structures are required for the control and measurement of the water flow.

7.2.1 Open Canal

An open canal, channel, or ditch, is an open waterway whose purpose is to carry water from one place to another. Channels and canals refer to main waterways supplying water to one or more farms. Field ditches have smaller dimensions and convey water from the farm entrance to the irrigated fields.

According to the shape of their cross-section, canals are called rectangular, trapezoidal, triangular, circular, or irregular or natural (Fig. 14). The most commonly used canal cross-section in irrigation and drainage is the trapezoidal cross-section (c).

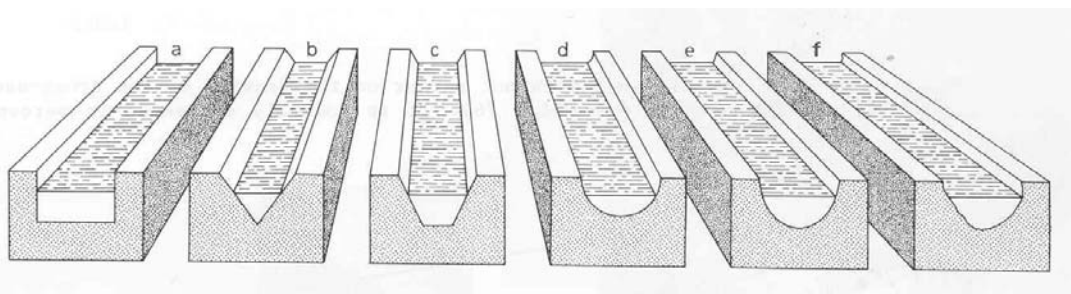

Fig. 14 Some examples of canal cross-sections

Canals can be either earthen (Fig. 15 and 16) or lined (Fig. 17). Earthen canals are simply dug in the ground and the bank is made up from the removed earth. The disadvantages of earthen canals are the risk of the side slopes collapsing and the water loss due to seepage. They also require continuous maintenance in order to control weed growth and to repair damage done by livestock, rodents, and crustaceans.

Earthen canals can be lined with impermeable materials to prevent excessive seepage and growth of weeds. Lining canal may also be an effective way to control the canal bottom and bank erosion.



Fig. 15 Construction of an earthen canal



Fig. 16 Maintenance of an earthen canal



Fig. 17 Lined canal

7.2.2 Canal Structure

The flow of irrigation water in the canals must always be under control. For this purpose, canal structures are required. They help regulate the flow and deliver the correct amount of water to the different branches of the system and onwards to the irrigated fields. There are two main types of structures used in the canals:

- distribution control structures, and
- water measurement structures.

Distribution control structures

Distribution control structures are required for easy and accurate water distribution within the irrigation system and on the farm. Commonly used distribution control structures are checks, division boxes and turnouts.

Checks: To divert water from the field ditch to the field, it is often necessary to raise the water level in the ditch. Checks are structures placed across the ditch to block it temporarily and to raise upstream the water level. Checks can be permanent (Fig. 18) structures or portable (Fig. 19).

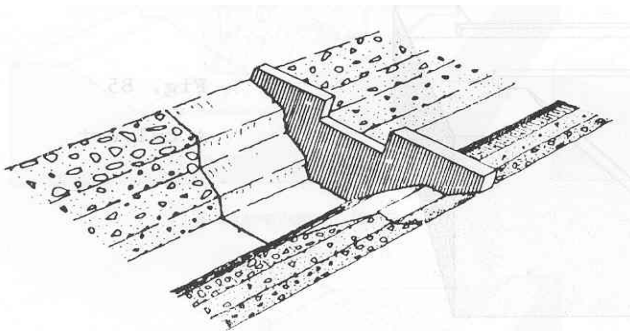

Fig. 18 A permanent concrete check

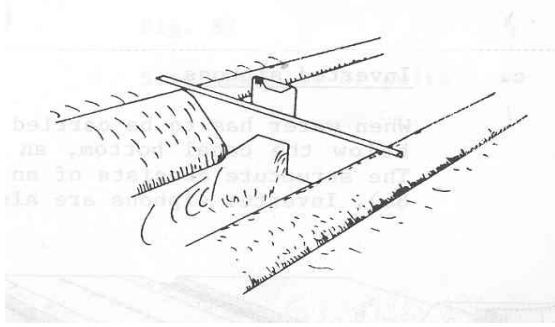

Fig. 19 A portable metal check

Division boxes: Division boxes are used to divide or direct the flow of water between two or more canals or ditches. Water enters the box through an opening on one side and flows out through openings on the other sides. These openings are equipped with gates (Fig. 20).

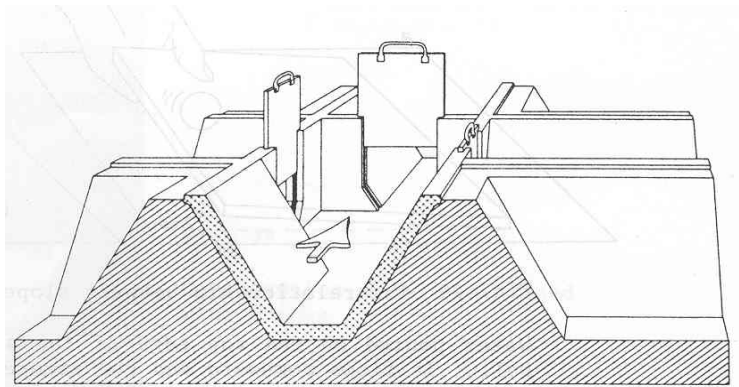

Fig. 20 A division box with three gates

Turnouts: Turnouts are constructed in the bank of a canal. They divert part of the water from the canal to a smaller channel or to the field. Turnouts can be concrete (Fig. 21) structures or pipe structures (Fig. 22).



Fig. 21 A concrete turnout

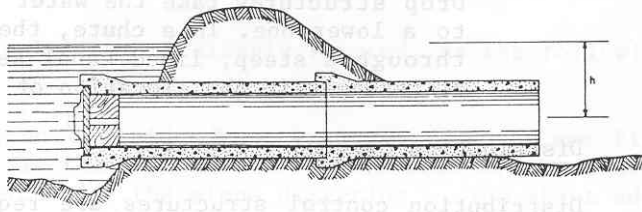

Fig. 22 A pipe turnout

Water Measurement Structures

The principal objective of measuring irrigation water is to permit efficient distribution and application. By measuring the flow of water, a farmer knows how much water is applied during each irrigation.

The most commonly used water measuring structures are weirs and flumes. In these structures, the water depth is read on a scale which is part of the structure. Using this reading, the flow rate is then computed from standard formulas or obtained from standard tables prepared for the structures.

Weirs: In the simplest form, a weir consists of a wall of timber, metal or concrete with an opening with fixed dimensions cut in its edge (Fig. 23). The opening, called a notch, may be rectangular, trapezoidal or triangular. Normally, a staff gauge (which is a stick with a measuring scale) is placed a short distance upstream from the weir or on the upper side of the weir itself. The depth of water measured on the staff gauge is related to a flow discharge table suitable for the type and size of weir used, in order to determine the flow rate. Flow rate is normally measured in units of liters per second, for small canals, or cubic meters per second for large canals.

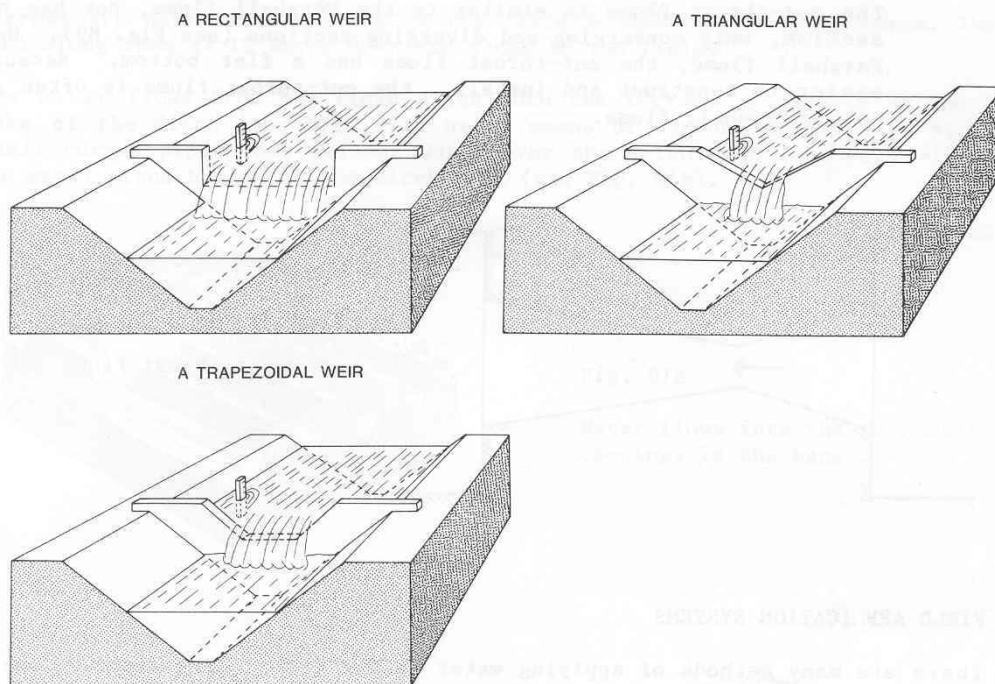

Fig. 23 Some examples of weirs

Parshall flume: The Parshall flume consists of a metal or concrete channel structure with three main sections:

- (i) a converging section at the unstream end,
- (ii) a constricted or throat section, and
- (iii) a diverging section at the downstream end (Fig. 24).

Depending on the flow condition (free flow or submerged flow) the water depth readings are taken on one scale only (upstream one) or on both scales simultaneously.

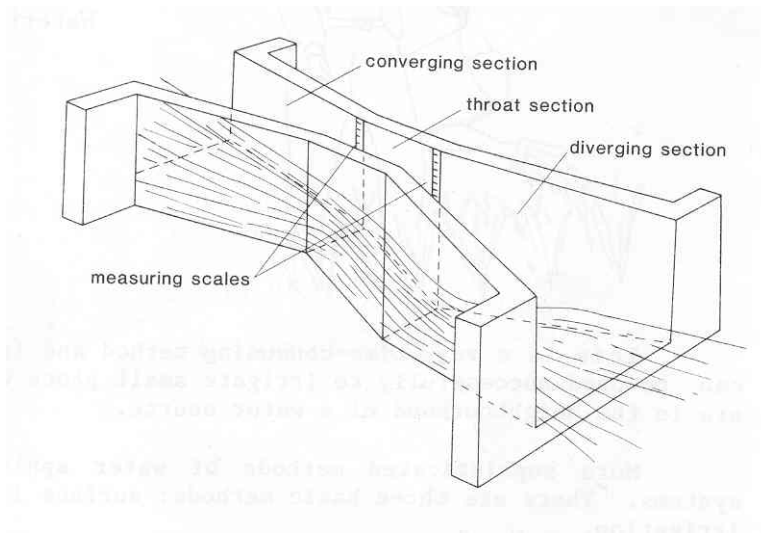

Fig. 24 A Parshall flume

Cut-throat flume: The cut-throat flume is similar to the Parshall flume, but has no throat section, only converging and diverging sections (Fig. 25). Unlike the Parshall flume, the cut-throat flume has a flat bottom. Because it is easier to construct and install, the cut-throat flume is often preferred to the Parshall flume.

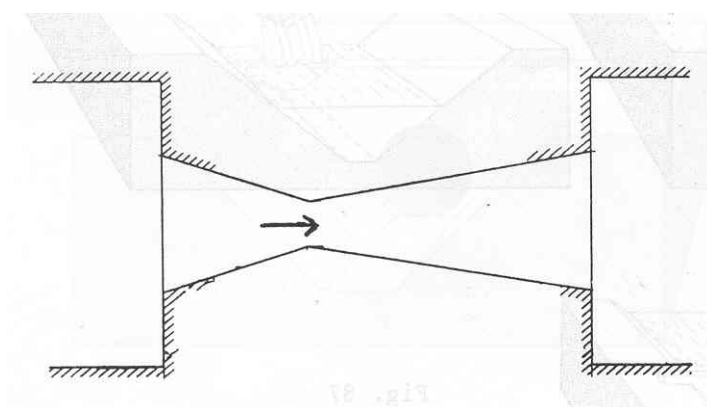

Fig. 25 A cut-throat flume

7.3 Field Application Systems

The field application system assures the transport of water within the fields. There are many methods of applying water to the field. The most common one is surface irrigation.

Surface irrigation is the application of water to the fields at ground level. Either the entire field is flooded or the water is directed into furrows or borders.

Furrow irrigation: Furrows are narrow ditches dug on the field between the rows of crops. The water runs along them as it moves down the slope of the field (Fig. 26).

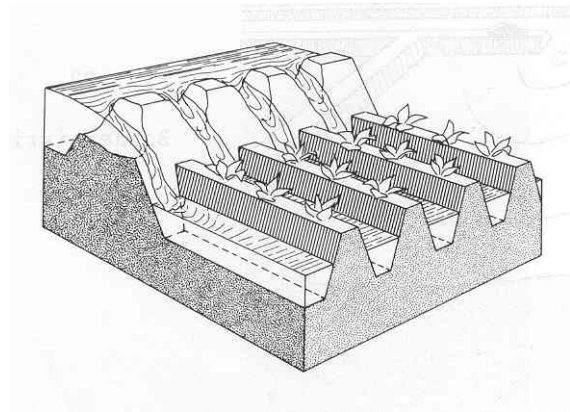

Fig. 26 Furrow irrigation

Border irrigation: In border irrigation, the field to be irrigated is divided into strips by parallel dykes or border ridges (Fig. 27). The water is released from the field ditch onto the border through gate structures called outlets.

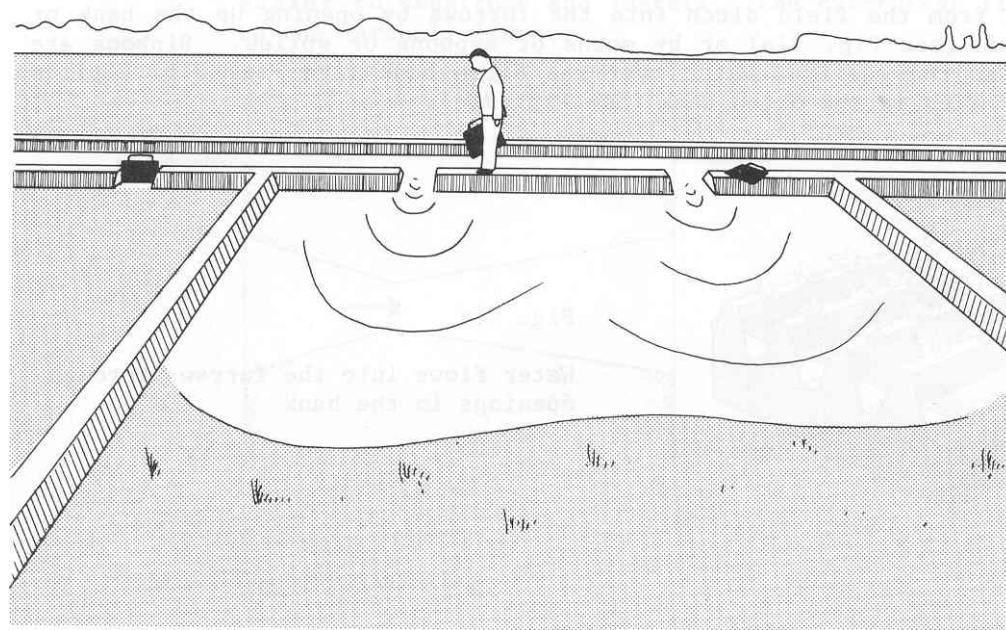

Fig. 27 Border irrigation

Basin Irrigation: Basins are horizontal, flat plots of land, surrounded by small dykes and bunds. The bank prevents the water from flowing to the surrounding fields. Basin irrigation is commonly used for rice grown on flat lands or in terraces on hillsides (Fig. 28).



Fig. 28 Basin irrigation

7.4 Drainage Systems

Agricultural drainage may be defined as artificial removal of excess water from the soil or from the land surface. The main purpose of drainage is to make the land more suitable for agricultural production, to increase productivity of soil, or to reduce production costs – all helping the farmer to maximize his net profit.

The drainage system removes the excess water (caused by rainfall and/or irrigation) from the fields.

7.4.1 Drainage needs

Drainage can be a necessity in many areas and for many reasons. The surplus water problem may be the result of surface runoff, melting snow and rainfall, seepage or leakage from canals and other distributaries of water supply systems, at artesian water, and deep percolation and waste from irrigated farms.

An efficient drainage system should ultimately be provided in all irrigated areas where natural conditions are inadequate to remove water that exceeds crop needs. All water that is not utilized by crops or vegetation or disposed of by nature through evaporation or deep percolation, must be disposed of in some manner. When an area controlled by an agency needs drainage, such as in humid areas, the organization operates and maintains adequate drainage facilities. Plans for a drainage system should be initiated coincidental with a water distribution system when it is determined that drainage will be necessary, and the systems should be constructed and available for use before drainage problems become acute.

7.4.2 Symptoms

Many irrigation system operators encounter the problem of poorly drained lands. Symptoms of the problem include rising groundwater, waterlogging,

salinization, soil deterioration, poor crop response, and other natural indicators. When these symptoms are found, or are anticipated, the next step is to find the cause of the problem. This might be canal and lateral seepage, excessive irrigation, water quality, inadequate natural drainage, or subsurface stratigraphic conditions.

In most irrigated areas there are two types of drainage problems with which operating personnel are concerned – surface and subsurface. In most instances, the operating agency or FWUC may provide the conveyance and improvements necessary to carry excess water generated by irrigation waste, storms, and other surface drainage water out of an area, minimizing the damage. A system of this type also may include provision for carrying water originating at a higher elevation through an irrigated area with minimum damage to the irrigation facilities and water user's crops and land.

7.4.3 Drainage as Return Flow as Water Supply

A drainage practice which may also serve as a water conservation measure is construction of sumps in drainage systems or retaining pools for the collection of excess surface water. The water from the conservation areas may be returned to the system or released to natural channels. Pumps are sometimes necessary to evacuate the impounded water.

The return flow from drainage or any other excess surface water can be used to recharge groundwater supplies. In some areas groundwater recharge may be accomplished by releasing excess surface water to natural channels. It may be beneficial to place check dams in streambeds to reduce the velocity of the water so that the percolation downward to the groundwater table will be promoted. Spreading basins operated separately or in conjunction with settling basins may also be effective in promoting groundwater recharge. Recharge wells may be drilled, but settling or filtering of the water may be required to sustain the efficiency of any well.

Appendix

Table A.1 Extra Terrestrial Radiation (Ra) expressed in equivalent evaporation in mm/day

Northern Hemisphere													Lat	Southern Hemisphere											
Jan	Feb	Mar	Apr	May	June	July	Aug	Sept	Oct	Nov	Dec	Jan		Feb	Mar	Apr	May	June	July	Aug	Sept	Oct	Nov	Dec	
3.8	6.1	9.4	12.7	15.8	17.1	16.4	14.1	10.9	7.4	4.5	3.2	50°	17.5	14.7	10.9	7.0	4.2	3.1	3.5	5.5	8.9	12.9	16.5	18.2	
4.3	6.6	9.8	13.0	15.9	17.2	16.5	14.3	11.2	7.8	5.0	3.7	48	17.6	14.9	11.2	7.5	4.7	3.5	4.0	6.0	9.3	13.2	16.6	18.2	
4.9	7.1	10.2	13.3	16.0	17.2	16.6	14.5	11.5	8.3	5.5	4.3	46	17.7	15.1	11.5	7.9	5.2	4.0	4.4	6.5	9.7	13.4	16.7	18.3	
5.3	7.6	10.6	13.7	16.1	17.2	16.6	14.7	11.9	8.7	6.0	4.7	44	17.8	15.3	11.9	8.4	5.7	4.4	4.9	6.9	10.2	13.7	16.7	18.3	
5.9	8.1	11.0	14.0	16.2	17.3	16.7	15.0	12.2	9.1	6.5	5.2	42	17.8	15.5	12.2	8.8	6.1	4.9	5.4	7.4	10.6	14.0	16.8	18.3	
6.4	8.6	11.4	14.3	16.4	17.3	16.7	15.2	12.5	9.6	7.0	5.7	40	17.9	15.7	12.5	9.2	6.6	5.3	5.9	7.9	11.0	14.2	16.9	18.3	
6.9	9.0	11.8	14.5	16.4	17.2	16.7	15.3	12.8	10.0	7.5	6.1	38	17.9	15.8	12.8	9.6	7.1	5.8	6.3	8.3	11.4	14.4	17.0	18.3	
7.4	9.4	12.1	14.7	16.4	17.2	16.7	15.4	13.1	10.6	8.0	6.6	36	17.9	16.0	13.2	10.1	7.5	6.3	6.8	8.8	11.7	14.6	17.0	18.2	
7.9	9.8	12.4	14.8	16.5	17.1	16.8	15.5	13.4	10.8	8.5	7.2	34	17.8	16.1	13.5	10.5	8.0	6.8	7.2	9.2	12.0	14.9	17.1	18.2	
8.3	10.2	12.8	15.0	16.5	17.0	16.8	15.6	13.6	11.2	9.0	7.8	32	17.8	16.2	13.8	10.9	8.5	7.3	7.7	9.6	12.4	15.1	17.2	18.1	
8.8	10.7	13.1	15.2	16.5	17.0	16.8	15.7	13.9	11.6	9.5	8.3	30	17.8	16.4	14.0	11.3	8.9	7.8	8.1	10.1	12.7	15.3	17.3	18.1	
9.3	11.1	13.4	15.3	16.5	16.8	16.7	15.7	14.1	12.0	9.9	8.8	28	17.7	16.4	14.3	11.6	9.3	8.2	8.6	10.4	13.0	15.4	17.2	17.9	
9.8	11.5	13.7	15.3	16.4	16.7	16.6	15.7	14.3	12.3	10.3	9.3	26	17.6	16.4	14.4	12.0	9.7	8.7	9.1	10.9	13.2	15.5	17.2	17.8	
10.2	11.9	13.9	15.4	16.4	16.6	16.5	15.8	14.5	12.6	10.7	9.7	24	17.5	16.5	14.6	12.3	10.2	9.1	9.5	11.2	13.4	15.6	17.1	17.7	
10.7	12.3	14.2	15.5	16.3	16.4	16.4	15.8	14.6	13.0	11.1	10.2	22	17.4	16.5	14.8	12.6	10.6	9.6	10.0	11.6	13.7	15.7	17.0	17.5	
11.2	12.7	14.4	15.6	16.3	16.4	16.3	15.9	14.8	13.3	11.6	10.7	20	17.3	16.5	15.0	13.0	11.0	10.0	10.4	12.0	13.9	15.8	17.0	17.4	
11.6	13.0	14.6	15.6	16.1	16.1	16.1	15.8	14.9	13.6	12.0	11.1	18	17.1	16.5	15.1	13.2	11.4	10.4	10.8	12.3	14.1	15.8	16.8	17.1	
12.0	13.3	14.7	15.6	16.0	15.9	15.9	15.7	15.0	13.9	12.4	11.6	16	16.9	16.4	15.2	13.5	11.7	10.8	11.2	12.6	14.3	15.8	16.7	16.8	
12.4	13.6	14.9	15.7	15.8	15.7	15.7	15.1	14.1	12.8	12.0	11.4	14	16.7	16.4	15.3	13.7	12.1	11.2	11.6	12.9	14.5	15.8	16.5	16.6	
12.8	13.9	15.1	15.7	15.7	15.5	15.5	15.6	15.2	14.4	13.3	12.5	12	16.6	16.3	15.4	14.0	12.5	11.6	12.0	13.2	14.7	15.8	16.4	16.5	
13.2	14.2	15.3	15.7	15.5	15.3	15.3	15.5	15.3	14.7	13.6	12.9	10	16.4	16.3	15.5	14.2	12.8	12.0	12.4	13.5	14.8	15.9	16.2	16.2	
13.6	14.5	15.3	15.6	15.3	15.0	15.1	15.4	15.3	14.8	13.9	13.3	8	16.1	16.1	15.5	14.4	13.1	12.4	12.7	13.7	14.9	15.8	16.0	16.0	
13.9	14.8	15.4	15.4	15.1	14.7	14.9	15.2	15.3	15.0	14.2	13.7	6	15.8	16.0	15.6	14.7	13.4	12.8	13.1	14.0	15.0	15.7	15.8	15.7	
14.3	15.0	15.5	15.5	14.9	14.4	14.6	15.1	15.3	15.1	14.5	14.1	4	15.5	15.8	15.6	14.9	13.8	13.2	13.4	14.3	15.1	15.6	15.5	15.4	
14.7	15.3	15.6	15.3	14.6	14.2	14.3	14.9	15.3	15.3	14.8	14.4	2	15.3	15.7	15.7	15.1	14.1	13.5	13.7	14.5	15.2	15.5	15.3	15.1	
15.0	15.5	15.7	15.3	14.4	13.9	14.1	14.8	15.3	15.4	15.1	14.8	0	15.0	15.5	15.7	15.3	14.4	13.9	14.1	14.8	15.3	15.4	15.1	14.8	

Table A.2 Pan Coefficient (Kp) for Class A Pan

Class A pan	Case A: Pan placed in short green cropped area				Case B: Pan placed in dry fallow area			
	RH mean (%) →	low < 40	medium 40 -70	high > 70	Windward side distance of dry fallow (m)	low < 40	medium 40 -70	high > 70
Light	1	.55	.65	.75	1	.7	.8	.85
< 2	10	.65	.75	.85	10	.6	.7	.8
	100	.7	.8	.85	100	.55	.65	.75
	1 000	.75	.85	.85	1 000	.5	.6	.7
Moderate	1	.5	.6	.65	1	.65	.75	.8
2-5	10	.6	.7	.75	10	.55	.65	.7
	100	.65	.75	.8	100	.5	.6	.65
	1 000	.7	.8	.8	1 000	.45	.55	.6
Strong	1	.45	.5	.6	1	.6	.65	.7
5-8	10	.55	.6	.65	10	.5	.55	.65
	100	.6	.65	.7	100	.45	.5	.6
	1 000	.65	.7	.75	1 000	.4	.45	.55
Very strong	1	.4	.45	.5	1	.5	.6	.65
> 8	10	.45	.55	.6	10	.45	.5	.55
	100	.5	.6	.65	100	.4	.45	.5
	1 000	.55	.6	.65	1 000	.35	.4	.45

Table A.3 Conveyance, field canal, distribution and application efficiency

Conveyance Efficiency (Ec)		ICID/ILRI	
Continuous supply with no substantial change in flow		0.9	
Rotational supply in projects of 3,000 - 7,000 ha and rotation areas of 70 - 300 ha, with effective management		0.8	
Rotational supply in large schemes (>10,00 ha) and small schemes (<1,000 ha) with respective problematic communication and less effective management:			
based on predetermined schedule		0.7	
based on advance request		0.65	
Field Canal Efficiency (Eb)			
Blocks larger than 20 ha :	unlined	0.8	
	lined or piped	0.9	
Blocks up to 20 ha :	unlined	0.7	
	lined or piped	0.8	
Distribution Efficiency (Ed = Ec.Eb)			
Average for rotational supply with management and communication adequate		0.65	
sufficient		0.55	
insufficient		0.40	
poor		0.30	
Field Application Efficiency (Ea)		USDA	US (SCS)
Surface methods			
light soils		0.55	
medium soils		0.70	
heavy soils		0.60	
graded border			0.60-0.75
basin and level border			0.60-0.80
contour ditch			0.50-0.55
furrow			0.55-0.70
corrugation			0.50-0.70
Subsurface			Up to 0.80
Sprinkler, hot dry climate			0.60
moderate climate			0.70
humid and cool			0.80
Rice			0.32

ABOUT CROPWAT

CROPWAT is a decision support system developed by the Land and Water Development Division of Food and Agricultural Organization of the United Nations. Its main functions are:

To calculate:

- Reference evapotranspiration
- Crop water requirements
- Crop irrigation requirements

To develop:

- Irrigation schedules under various management conditions
- Scheme water supply

To evaluate:

- Rainfed production and drought effects
- Efficiency of irrigation practices

CROPWAT is meant as a practical tool to help agro-meteorologists, agronomists and irrigation engineers to carry out standard calculations for evapotranspiration and crop water use studies, and more specifically the design and management of irrigation schemes. It allows the development of recommendations for improved irrigation practices, the planning of irrigation schedules under varying water supply conditions, and the assessment of production under rainfed conditions or deficit irrigation.

Calculations of crop water requirements and irrigation requirements are carried out with inputs of climatic and crop data. Standard crop data are included in the program and climatic data can be obtained for 144 countries through the [CLIMWAT](#)-database. The development of irrigation schedules and evaluation of rainfed and irrigation practices are based on a daily soil-water balance using various options for water supply and irrigation management conditions. Scheme water supply is calculated according to the cropping pattern provided. Procedures for calculation of the crop water requirements and irrigation requirements are based on methodologies presented in FAO Irrigation and Drainage Papers No. 24 "Crop water requirements" and No. 33 "Yield response to water".

CROPWAT includes a revised method for estimating reference crop evapotranspiration, adopting the approach of Penman-Monteith as recommended by the FAO Expert Consultation held in May 1990 in Rome. Further details on the methodology are provided in the following paper: [Revised FAO Methodology for Crop Water Requirements](#) and in the new **Irrigation and Drainage Paper No 56.: "Crop Evapotranspiration"**.

CROPWAT version 5.7, issued in 1992, is written in BASIC and runs in the DOS environment. The program is available in English, French and Spanish, and is

distributed as Irrigation and Drainage paper No 46. which includes a manual and guidelines. The manual explains the use of the computer program. The guidelines elaborate on calculation procedures and applications in irrigation planning and management, with examples.

The **English version** of CROPWAT 5.7 is replaced by **CROPWAT version 7.0**. The program should be unzipped in a suitable directory. The proper directory structure will be restored after running the SETUP command.

The CROPWAT publication can be ordered as FAO Irrigation and Drainage Paper No. 46 through the FAO Sales and Marketing Group:  Publications-sales@FAO.ORG

CROPWAT version 7.0 contains a completely new version in Pascal, developed with the assistance of the Agricultural College of Velp, Netherlands. It overcomes many of the shortcomings of the original 5.7 version. It is concise and fits easily on one diskette. The program can be downloaded as [CROPWAT72.ZIP](#) (329 Kb) from FAO's FTP-server. After unzipping in a suitable directory or diskette, the original directory structure will be restored with the SETUP command. *CROPWAT 7.0 is a DOS-application, but it runs without any problem in all MS-WINDOWS environments.*

CROPWAT for WINDOWS contains a CROPWAT version in Visual Basic to operate in the Windows environment. It has been developed with the assistance of the International Irrigation & Development Institute (IIDS) of the University of Southampton, UK. The program and the manual in Acrobat format can be downloaded from FAO's FTP-server as [CRW4W3.ZIP](#) and [CRW4W-MN.ZIP](#), respectively. The program should be unzipped in a temporary directory and will be installed with the SETUP command as explained in the included **readme.txt** file.

A database facility [CLIMWAT](#) has been developed which allows a direct link from CROPWAT to an extensive climatic database of 3262 stations of 144 countries worldwide in Asia, Africa, Near East, South Europe, Central and South America. This has been published as FAO Irrigation and Drainage Paper No. 49. For further information and download of the data refer to the concerned [CLIMWAT](#)-page.

For comments and further information, please contact: Martin Smith (Martin.Smith@FAO.ORG), Senior Irrigation Management Officer Water Resources, Development and Management Service FAO, Viale delle Terme di Caracalla, 00100 Rome, Italy Tel: (39-06) 57053818, Fax: (39-06) 57056275